

9SX700
9SX1000
9SX1000G
9SX1500
9SX1500G
9SX2000
9SX2000G
9SX3000
9SX3000G
9SX3000GL
9SX3000HW
9SXEBM36
9SXEBM48
9SXEBM96

**Installation
and user manual**

SAFETY INSTRUCTIONS

SAVE THESE INSTRUCTIONS. This manual contains important instructions that should be followed during installation and maintenance of the UPS and batteries.

The 9SX models that are covered in this manual are intended for installation in an environment within 0 to 40 °C, free of conductive contaminant.

Please check section "6.1 Equipment care", page 30, for additional information.

Special symbols

The following are examples of symbols used on the UPS or accessories to alert you to important information:



RISK OF ELECTRIC SHOCK - Observe the warning associated with the risk of electric shock symbol.



Important instructions that must always be followed.



Do not discard the UPS or the UPS batteries in the trash.
This product contains sealed lead acid batteries and must be disposed as it's explain in this manual.
For more information, contact your local recycling/reuse or hazardous waste center.



This symbol indicates that you should not discard waste electrical or electronic equipment (WEEE) in the trash.
For proper disposal, contact your local recycling/reuse or hazardous waste center.



Information, advice, help.

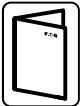

Refer to the user manual of UPS accessories.

Safety of persons

- The system has its own power source (the battery). Consequently, the power outlets may be energized even if the systems is disconnected from the AC power source. Dangerous voltage levels are present within the system. It should be opened exclusively by qualified service personnel.
- The system must be properly grounded.
- The battery supplied with the system contains small amounts of toxic materials.
To avoid accidents, the directives listed below must be observed:
 - Servicing of batteries should be performed or supervised by personnel knowledgeable about batteries and the required precautions.
 - When replacing batteries, replace with the same type and number of batteries or battery packs.
 - Do not dispose of batteries in a fire. The batteries may explode.
 - Batteries constitute a danger (electrical shock, burns). The short-circuit current may be very high.
- Precautions must be taken for all handling:
 - Wear rubber gloves and boots.
 - Do not lay tools or metal parts on top of batteries.
 - Disconnect charging source prior to connecting or disconnecting battery terminals.
 - Determine if battery is inadvertently grounded. If inadvertently grounded, remove source from ground. Contact with any part of a grounded battery can result in electrical shock. The likelihood of such shock can be reduced if such grounds are removed during installation and maintenance (applicable to equipment and remote battery supplies not having a grounded supply circuit).

Product safety

- The UPS connection instructions and operation described in the manual must be followed in the indicated order.
- CAUTION - To reduce the risk of fire, the unit connects only to a circuit provided with 15, 20 or 30 amperes maximum branch circuit overcurrent protection in accordance with the National Electric Code, ANSI/NFPA 70 (US installations only).
- Check that the indications on the rating plate correspond to your AC powered system and to the actual electrical consumption of all the equipment to be connected to the system.
- For PLUGGABLE EQUIPMENT, the socket-outlet shall be installed near the equipment and shall be easily accessible.
- Never install the system near liquids or in an excessively damp environment.
- Never let a foreign body penetrate inside the system.
- Never block the ventilation grates of the system.
- Never expose the system to direct sunlight or source of heat.
- If the system must be stored prior to installation, storage must be in a dry place.
- The admissible storage temperature range is -25 °C to +55 °C without batteries, 0 °C to +40 °C with batteries.
- The system is not for use in a computer room AS DEFINED IN the standard for the Protection of Information Technology Equipment, ANSI/NFPA 75 (US installations only).

SAFETY INSTRUCTIONS

Special precautions

- The unit is heavy: wear safety shoes and use lifter preferentially for handling operations.
- All handling operations will require at least two (2) people (unpacking, lifting, installation in rack system).
- Before and after the installation, if the UPS remains de-energized for a long period, the UPS must be energized for a period of 24 hours, at least once every 6 months (for a normal storage temperature less than 25 °C). This charges the battery, thus avoiding possible irreversible damage.
- During the replacement of the Battery Module, it is imperative to use the same type and number of element as the original Battery Module provided with the UPS to maintain an identical level of performance and safety. If there are any questions, don't hesitate to contact your EATON representative.
- All repairs and service should be performed by AUTHORIZED SERVICE PERSONNEL ONLY. There are NO USER SERVICEABLE PARTS inside the UPS.
- For potential safety issue on defective UPS: DISCONNECT INTERNAL BATTERY for storage and transportation.

1. Introduction.....	6
1.1 Environmental protection.....	6
2. Presentation.....	8
2.1 Standard installations.....	8
2.2 Rear panels.....	8
2.3 Accessories.....	11
3. Installation.....	12
3.1 Inspecting the equipment.....	12
3.2 UPS Tower 0-3KVA.....	12
3.3 EBM Tower 0-3KVA.....	16
3.4 Connecting other accessories.....	16
4. Interfaces and Communication.....	17
4.1 Control panel.....	17
4.2 LCD description.....	18
4.3 Display functions.....	19
4.4 User settings.....	19
4.5 Communication ports.....	23
4.6 UPS remote control functions.....	24
4.7 Eaton Intelligent Power Software suite.....	26
4.8 Cybersecurity.....	26
5. Operation.....	27
5.1 Start-up and Normal operation.....	27
5.2 Starting the UPS on Battery.....	27
5.3 UPS Shutdown.....	27
5.4 Operating modes.....	27
5.5 Return of AC Input Power.....	28
5.6 Setting High Efficiency mode.....	28
5.7 Configuring Bypass settings.....	28
5.8 Configuring battery settings.....	29
5.9 Retrieving the Event log.....	29
5.10 Retrieving the Fault log.....	29
6. UPS maintenance.....	30
6.1 Equipment care.....	30
6.2 Storing the equipment.....	30
6.3 When to replace batteries.....	30
6.4 Replacing batteries.....	31
6.5 Recycling the used equipment.....	33
7. Troubleshooting.....	34
7.1 Typical alarms and faults.....	34
7.2 Silencing the alarm.....	35
7.3 Service and support.....	35
7.4 CE compliance contact.....	35
8. Specifications.....	36
8.1 Model specifications.....	36
9. Glossary.....	41

1. Introduction

Thank you for selecting an EATON product to protect your electrical equipment.

The 9SX range has been designed with the utmost care.

We recommend that you take the time to read this manual to take full advantage of the many features of your UPS (Uninterruptible Power Supply).

Before installing your 9SX, please read the booklet presenting the safety instructions.

Then follow the indications in this manual.

To discover the entire range of EATON products and the options available for the 9SX range, we invite you to visit our web site at www.eaton.com/powerquality or contact your EATON representative.

1.1 Environmental protection

EATON has implemented an environmental-protection policy.

Products are developed according to an eco-design approach.

Substances

This product does not contain CFCs, HCFCs or asbestos.

Packing

To improve waste treatment and facilitate recycling, separate the various packing components.

- The cardboard we use comprises over 50% of recycled cardboard.
- Sacks and bags are made of polyethylene.
- Packing materials are recyclable and bear the appropriate identification symbol 

Materials	Abbreviations	Number in  the symbols
Polyethylene terephthalate	PET	01
High-density polyethylene	HDPE	02
Polyvinyl chloride	PVC	03
Low-density polyethylene	LDPE	04
Polypropylene	PP	05
Polystyrene	PS	06

Follow all local regulations for the disposal of packing materials.

End of life

EATON will process products at the end of their service life in compliance with local regulations.

EATON works with companies in charge of collecting and eliminating our products at the end of their service life.

Product

The product is made up of recyclable materials.

Dismantling and destruction must take place in compliance with all local regulations concerning waste.

At the end of its service life, the product must be transported to a processing center for electrical and electronic waste.

Battery

The product contains lead-acid batteries that must be processed according to applicable local regulations concerning batteries.

The battery may be removed to comply with regulations and in view of correct disposal.

The EATON 9SX uninterruptible power system (UPS) protects your sensitive electronic equipment from the most common power problems, including power failures, power sags, power surges, brownouts, line noise, high voltage spikes, frequency variations, switching transients, and harmonic distortion. Power outages can occur when you least expect it and power quality can be erratic. These power problems have the potential to corrupt critical data, destroy unsaved work sessions, and damage hardware - causing hours of lost productivity and expensive repairs.

With the EATON 9SX, you can safely eliminate the effects of power disturbances and guard the integrity of your equipment. Providing outstanding performance and reliability, the EATON 9SX's unique benefits include:

- True online double-conversion technology with high power density, utility frequency independence, and generator compatibility.
- ABM® technology that uses advanced battery management to increase battery service life, optimize recharge time, and provide a warning before the end of useful battery life.
- Selectable High Efficiency mode of operation.
- Standard communication options: one RS-232 communication port, one USB communication port, and relay output contacts.
- Optional connectivity cards with enhanced communication capabilities.
- Extended runtime with up to four Extended Battery Modules (EBMs) per UPS.
- Remote On/Off control.
- Backed by worldwide agency approvals.

2. Presentation

2.1 Standard installation

Tower installation

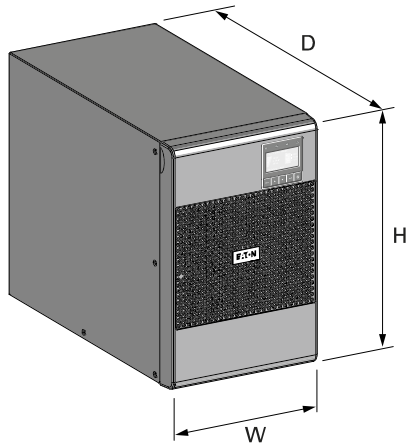

Description	Weights (lb/kg)	Dimensions (inch/mm) W x H x D
9SX700	25.4 / 11.5	6.3 x 9.9 x 14.1 / 160 x 252 x 357
9SX1000	32.6 / 14.8	6.3 x 9.9 x 15.2 / 160 x 252 x 387
9SX1500	40.8 / 18.5	6.3 x 9.9 x 15.2 / 160 x 252 x 387
9SX2000	73.4 / 33.3	8.4 x 13.6 x 16.2 / 214 x 346 x 412
9SX3000	73.6 / 33.4	8.4 x 13.6 x 16.2 / 214 x 346 x 412
9SX3000HW	73.9 / 33.5	8.4 x 13.6 x 16.2 / 214 x 346 x 412
9SX1000G	25.4 / 11.5	6.3 x 9.9 x 15.2 / 160 x 252 x 387
9SX1500G	32.6 / 14.8	6.3 x 9.9 x 15.2 / 160 x 252 x 387
9SX2000G	73.4 / 33.3	8.4 x 13.6 x 16.2 / 214 x 346 x 412
9SX3000G	73.6 / 33.4	8.4 x 13.6 x 16.2 / 214 x 346 x 412
9SX3000GL	73.6 / 33.4	8.4 x 13.6 x 16.2 / 214 x 346 x 412
9SXEBM36V	41.9 / 19	6.3 x 9.9 x 15.2 / 160 x 252 x 387
9SXEBM48V	54 / 24.5	6.3 x 9.9 x 15.2 / 160 x 252 x 387
9SXEBM96V	107.4 / 48.7	8.4 x 13.6 x 16.2 / 214 x 346 x 412

2.2 Rear panels

9SX700

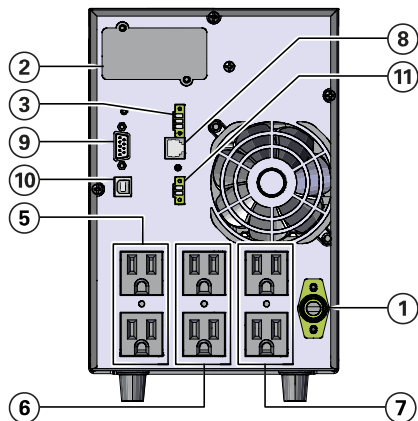

- ① Input AC power source
- ② Slot for optional communication card
- ③ Relay output contact
- ④ Connector for Extended Battery Modules
- ⑤ Primary outlets
- ⑥ Group 1: programmable outlets
- ⑦ Group 2: programmable outlets
- ⑧ Connector for automatic recognition of an additional battery module
- ⑨ RS232 communication port
- ⑩ USB communication port
- ⑪ RPO port (Remote Power Off)

2. Presentation

9SX1000

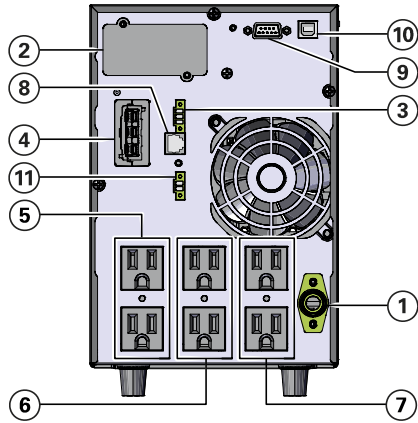

- ① Input AC power source
- ② Slot for optional communication card
- ③ Relay output contact
- ④ Connector for Extended Battery Modules
- ⑤ Primary outlets
- ⑥ Group 1: programmable outlets
- ⑦ Group 2: programmable outlets
- ⑧ Connector for automatic recognition of an additional battery module
- ⑨ RS232 communication port
- ⑩ USB communication port
- ⑪ RPO port (Remote Power Off)

9SX1000G

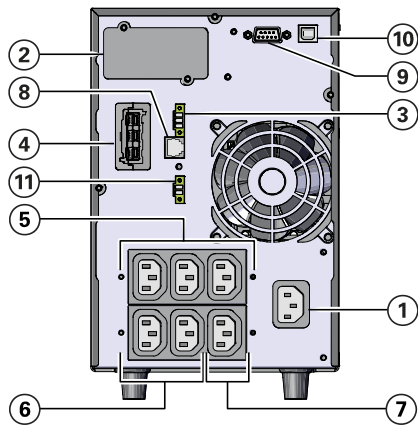

9SX1500

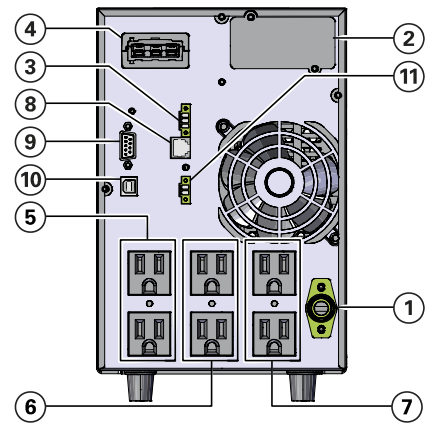

9SX1500G

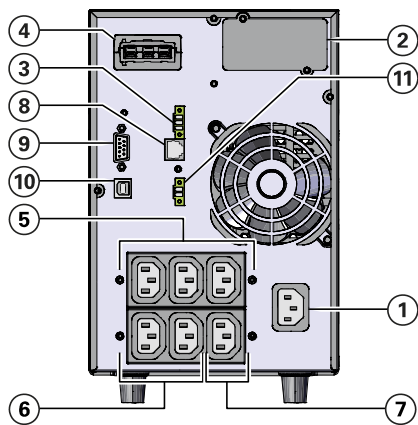

9SX2000

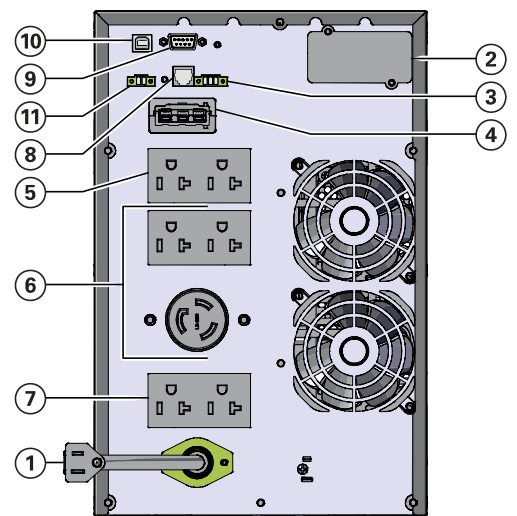

2. Presentation

9SX2000G

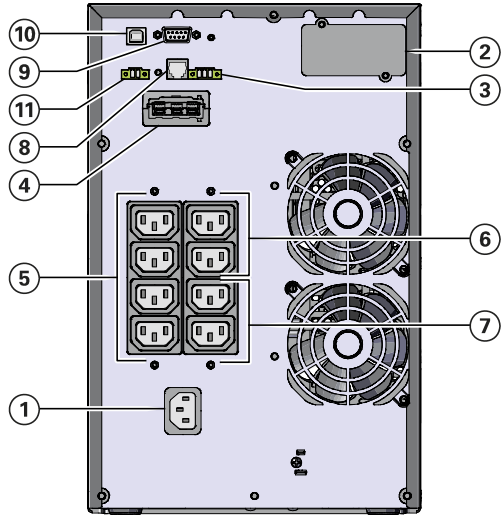

- ① Input AC power source
- ② Slot for optional communication card
- ③ Relay output contact
- ④ Connector for Extended Battery Modules
- ⑤ Primary outlets
- ⑥ Group 1: programmable outlets
- ⑦ Group 2: programmable outlets
- ⑧ Connector for automatic recognition of an additional battery module
- ⑨ RS232 communication port
- ⑩ USB communication port
- ⑪ RPO port (Remote Power Off)
- ⑫ Output AC

9SX3000

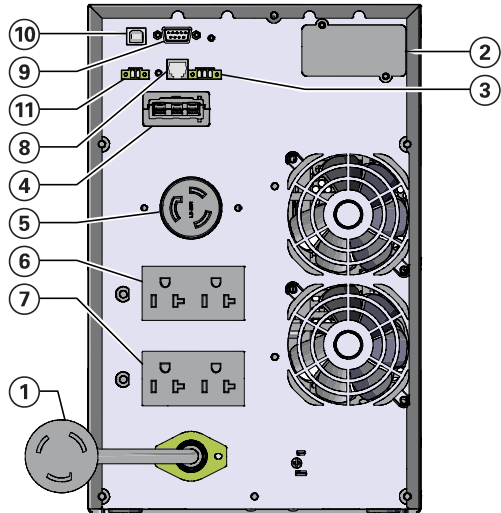

9SX3000G

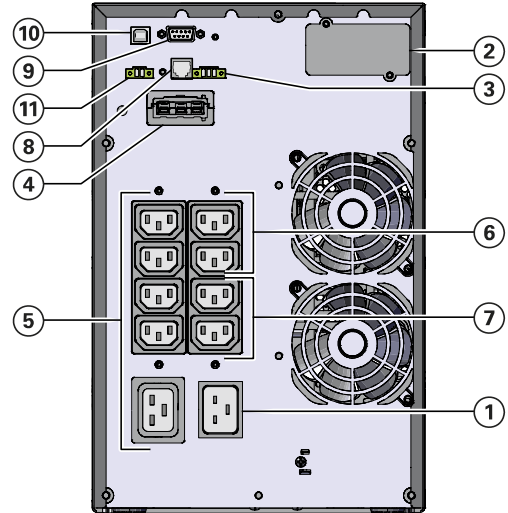

9SX3000GL

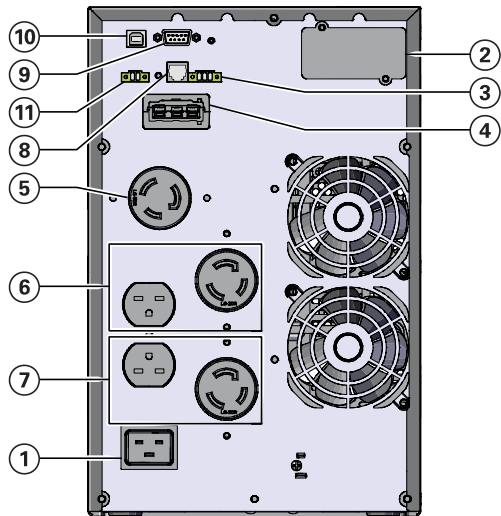

9SX3000HW

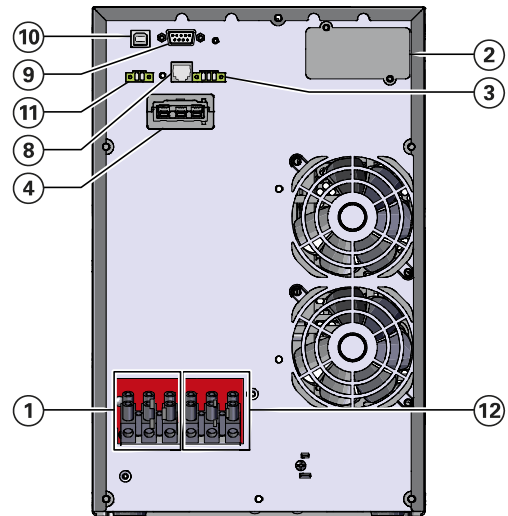

2. Presentation

9SXEBM36 / 9SXEBM48

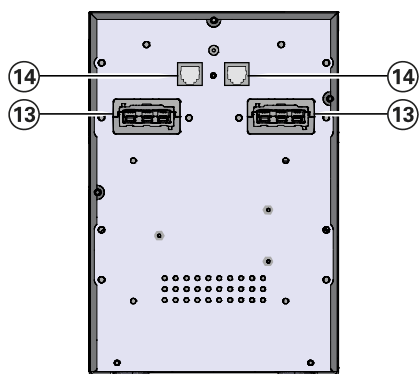

- ⑬ Connector for Extended Battery Modules (to the UPS or to the other battery modules)
- ⑭ Connectors for automatic recognition of battery modules

9SXEBM96

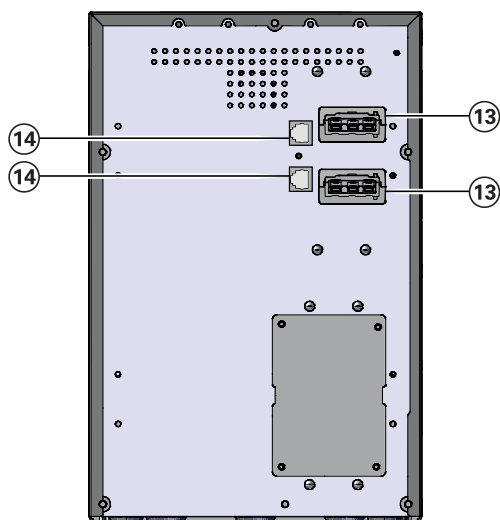

2.3 Accessories

Part number	Description
Network-MS / Network M2	Network card
Modbus-MS	Modbus and network card
INDGW-M2	Industrial Gateway Card MiniSlot
Relay-MS	Relay card
INDRELAY-MS	Industrial relay card
EBMCBL36T EBMCBL48T EBMCBL96T	Eaton 2 m cable 36V EBM Tower Eaton 2 m cable 48V EBM Tower Eaton 2 m cable 96V EBM Tower

3. Installation

3.1 Inspecting the equipment

If any equipment has been damaged during shipment, keep the shipping cartons and packing materials for the carrier or place of purchase and file a claim for shipping damage. If you discover damage after acceptance, file a claim for concealed damage.

To file a claim for shipping damage or concealed damage:

1. File with the carrier within 15 days of receipt of the equipment;
2. Send a copy of the damage claim within 15 days to your service representative.



Check the battery recharge date on the shipping carton label. If the date has passed and the batteries were never recharged, do not use the UPS. Contact your service representative.

3.2 UPS Tower 0-3KVA

A - Checking the accessory kit

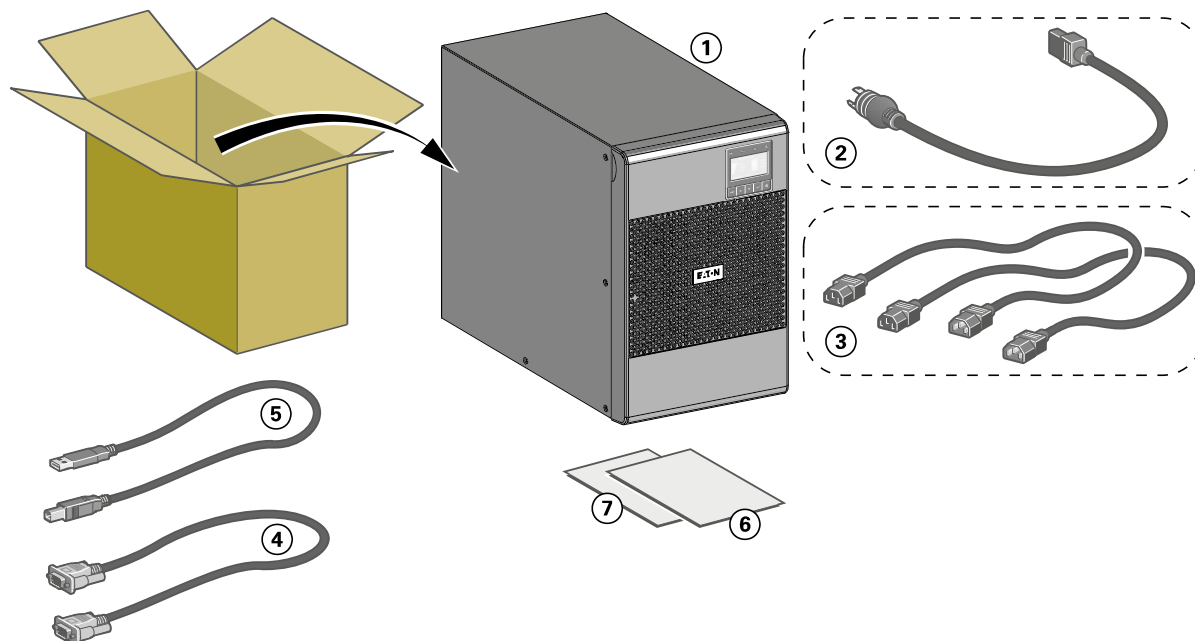

- Verify that the following additional items are included with the UPS:

- ① 9SX UPS
- ② Connection cable to AC-power source (**9SX2000G / 9SX3000G / 9SX3000GL** models only)
- ③ 2 connection cables for the protected equipment (**9SX1000G / 9SX1500G / 9SX2000G / 9SX3000G** models only)
- ④ RS232 communication cable
- ⑤ USB communication cable
- ⑥ Safety instructions
- ⑦ Quick start

B - Installation

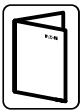

If you ordered other UPS accessories, refer to specific user manuals to check the tower installation with the UPS.

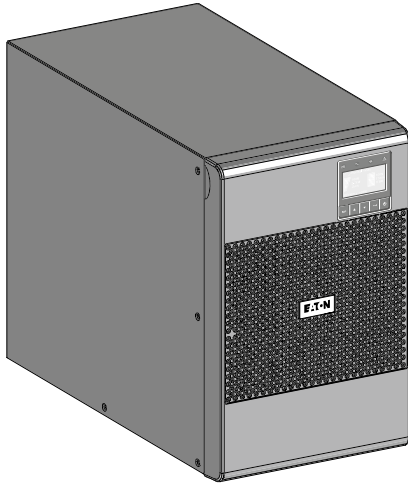

1. Place the UPS on a flat, stable surface in its final location.
2. Always keep 150 mm of free space behind the UPS rear panel.

C - Connecting the internal batterie

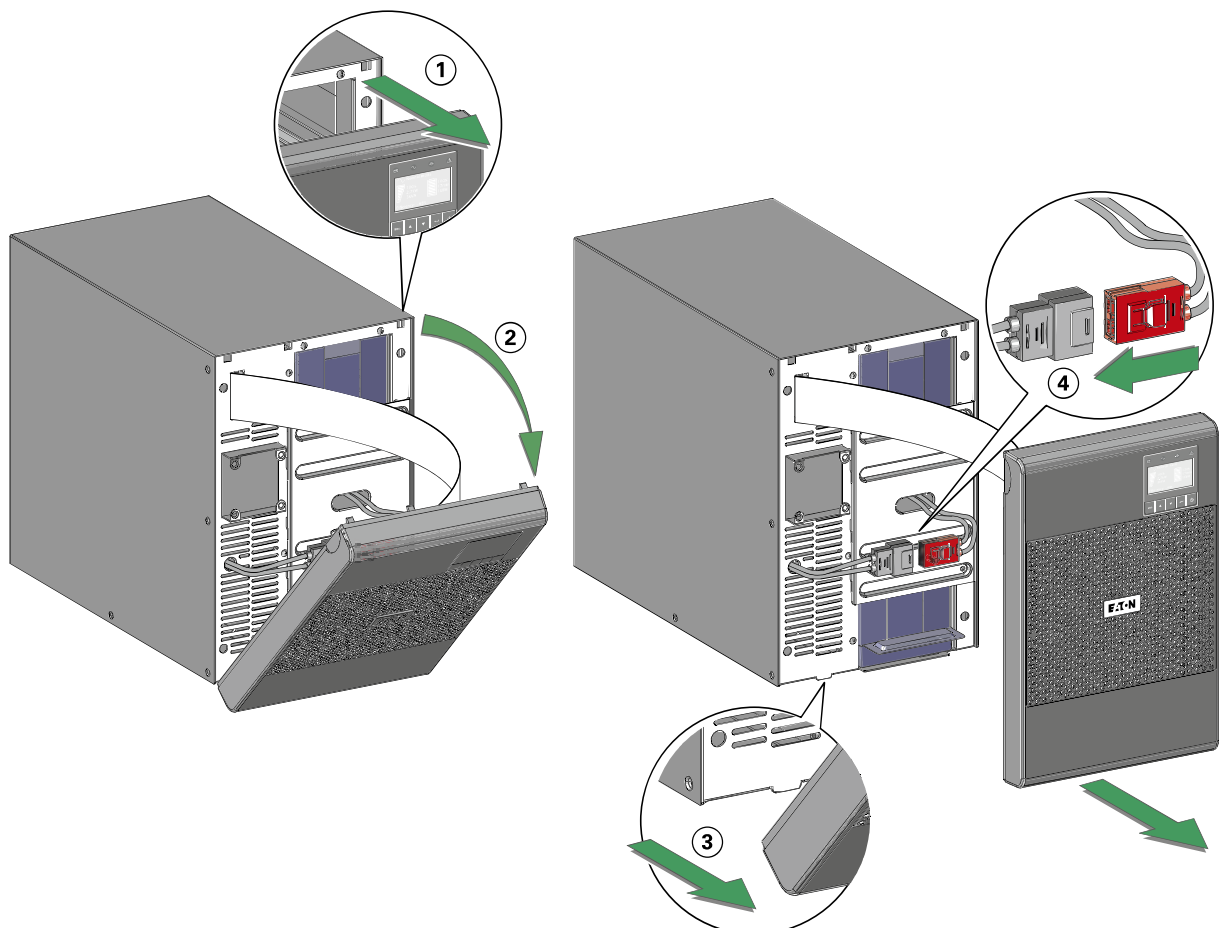

1. Unlock the holders on the upper part of the front panel.
2. Rotate the front face down.
3. Remove the lower part of the front panel.



A ribbon cable connects the LCD control panel to the UPS. Do not pull on the cable or disconnect it.

4. Connect the internal battery connector.
5. Reassemble in the reverse order.

3. Installation

D - UPS connection (Except 9SX3000HW)



Check that the indications on the name plate located on the back of the UPS meets to the AC-power source and the true electrical consumption of the total load.

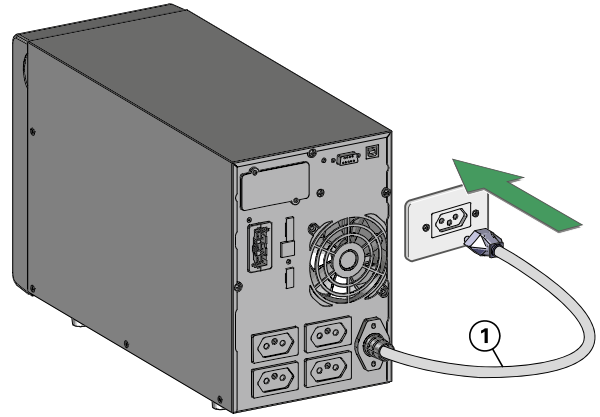
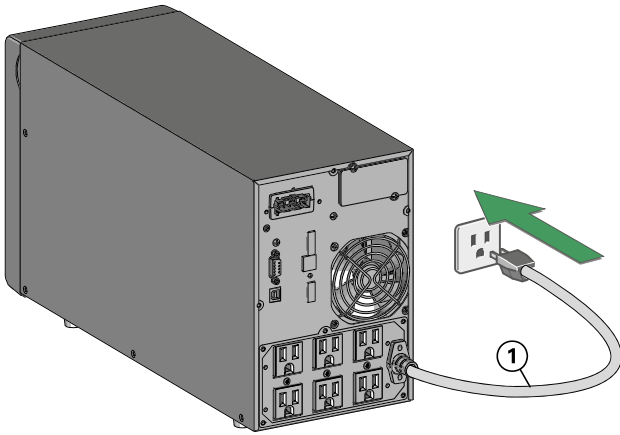

1. Connect the UPS input cord (1) to the AC-power source. (except models **9SX1000G** / **9SX1500G** / **9SX2000G** / **9SX3000G** / **9SX3000GL**).

Models **9SX1000G** / **9SX1500G** use the input cable (15) of the protected equipment.

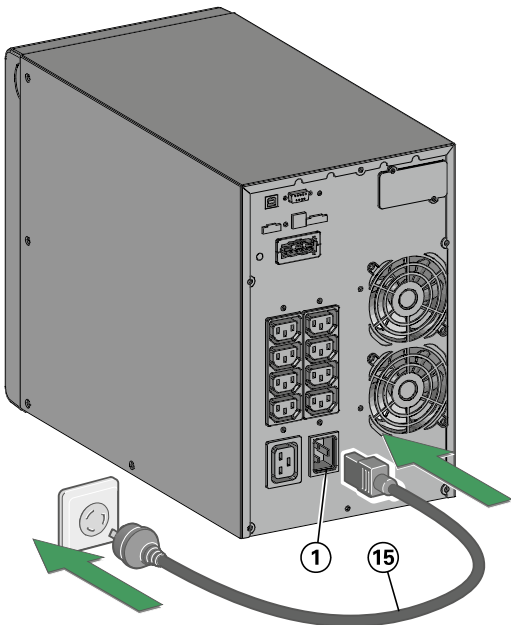

Models **9SX2000G** / **9SX3000G** / **9SX3000GL**: connect the input cable (15) (250V – 16A) provided to the socket (1), then to the AC-power source (see chapter "2.2 Rear Panels").

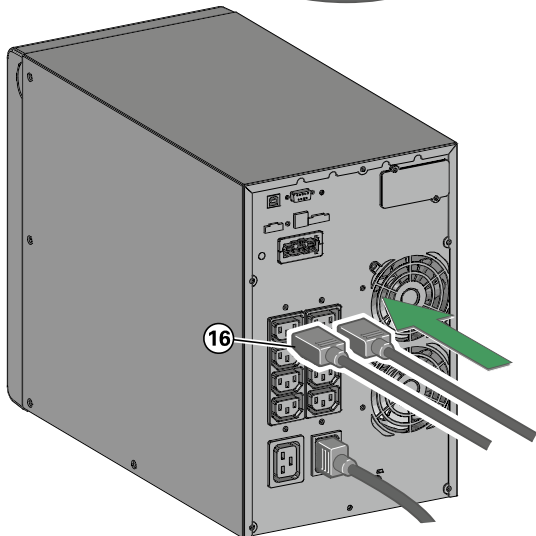

2. Connect the loads to the UPS using the cables (16). It is preferable to connect the priority loads to the outlets marked (5) and the non-priority loads to the outlets marked (6) (7) that can be programmed (See Chapter "2.2 Rear Panels"). Connect any high-power devices to the 16 A outlet.

To program shutdown of outlets (6) (7) (See Chapter "2.2 Rear Panels") during operation on battery power and thus optimise the available backup time, please check the in/out settings.



Note: The UPS charges the battery as soon as it is connected to the AC-power source, even if  button is not pressed.

Once the UPS is connected to the AC-power source, 24 hours of charging are required before the battery can supply the rated backup time.

E - UPS connection 9SX3000HW



Check that the indications on the name plate located on the back of the UPS meets to the AC-power source and the true electrical consumption of the total load.

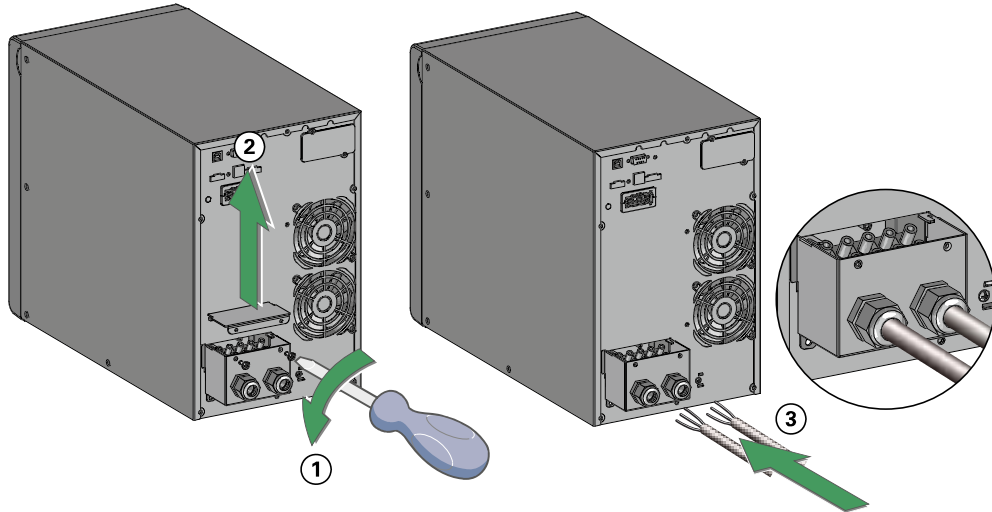

1. Loosen and remove the 2 retaining screws from the cover.
2. Remove the cover.
3. Pass the 2 cables through the cable glands.

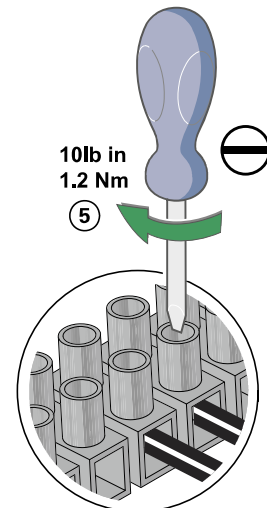
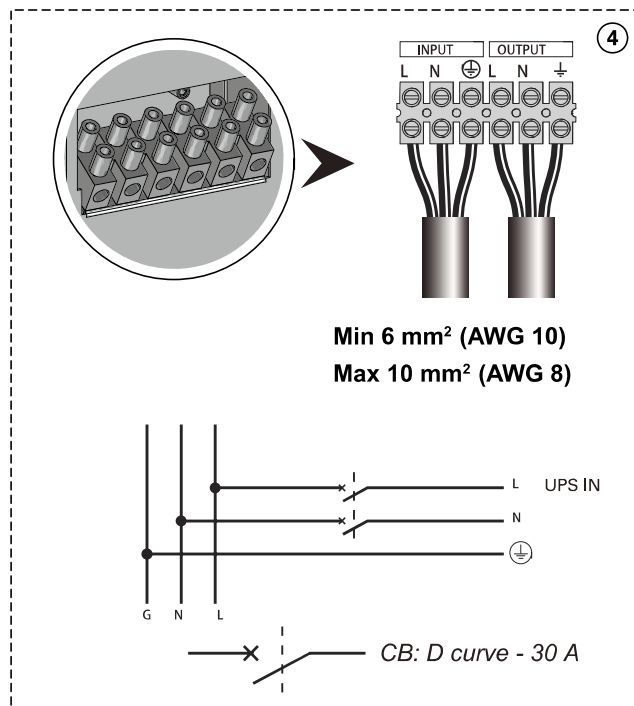

4. Connect the cables as shown in the diagram.
5. Tighten the cables.
6. Tighten the cable glands.
7. Put back the cover and tighten the 2 screws.



Note: The UPS charges the battery as soon as it is connected to the AC-power source, even if button is not pressed.

Once the UPS is connected to the AC-power source, 24 hours of charging are required before the battery can supply the rated backup time.

3. Installation

3.3 EBM Tower 0-3KVA

A - Checking the accessory EBM

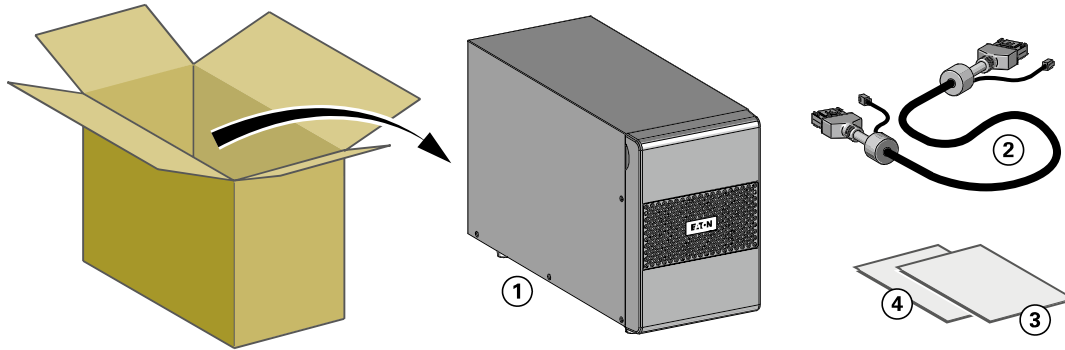

- ① 9SX EBM
- ② Battery power cable, attached with battery detection cable
- ③ Quick start
- ④ EBM Installation manual.



Discard the EBM user's guide if you are installing the EBM with a new UPS at the same time. Use the UPS user's guide to install both the UPS and the EBM.

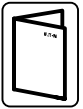

If you ordered other UPS accessories, refer to specific user manuals to check the packing contents.

B - Connecting the EBM

1. Plug the EBM power cable(s) into the battery connector(s). Up to 4 EBMs may be connected to the UPS.
2. Verify that the EBM connections are tight and that adequate bend radius and strain relief exist for each cable.
3. Connect the battery detection cable(s) to the connector of the UPS and of the EBM(s).

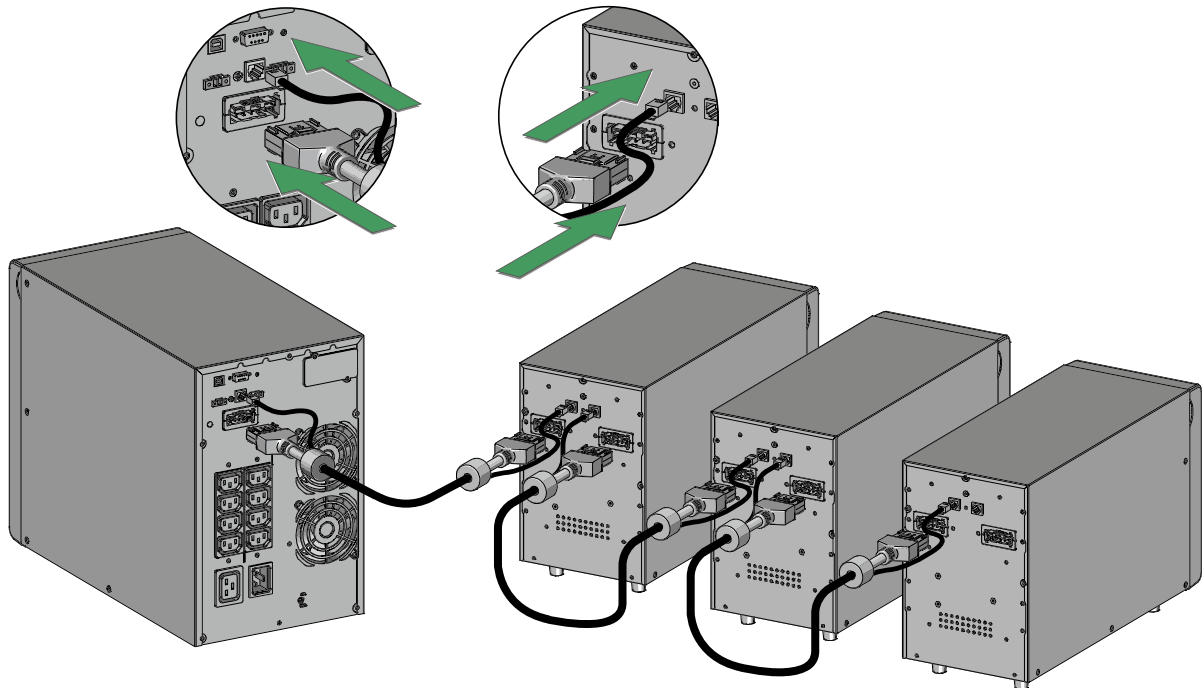

3.4 Connecting other accessories

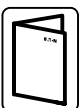

If you ordered other UPS accessories, refer to specific user manuals to check the connection to the UPS.



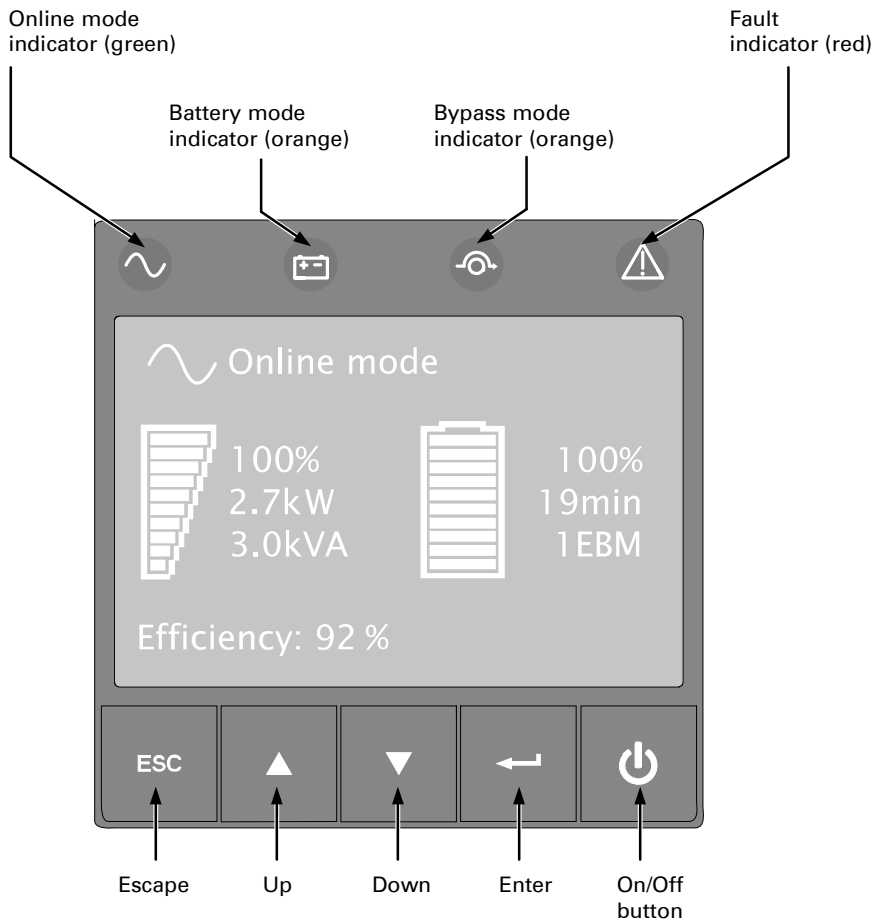

4. Interfaces and Communication

4.1 Control panel

The UPS has a five-button graphical LCD. It provides useful information about the UPS itself, load status, events, measurements and settings.



The following table shows the indicator status and description:

Indicator	Status	Description
 Green	On	The UPS is operating normally on Online or on High Efficiency mode.
 Orange	On	The UPS is on Battery mode.
 Orange	On	The UPS is on Bypass mode.
 Red	On	The UPS has an active alarm or fault. See troubleshooting on page 34 for additional information.

4. Interfaces and Communication

4.2 LCD description





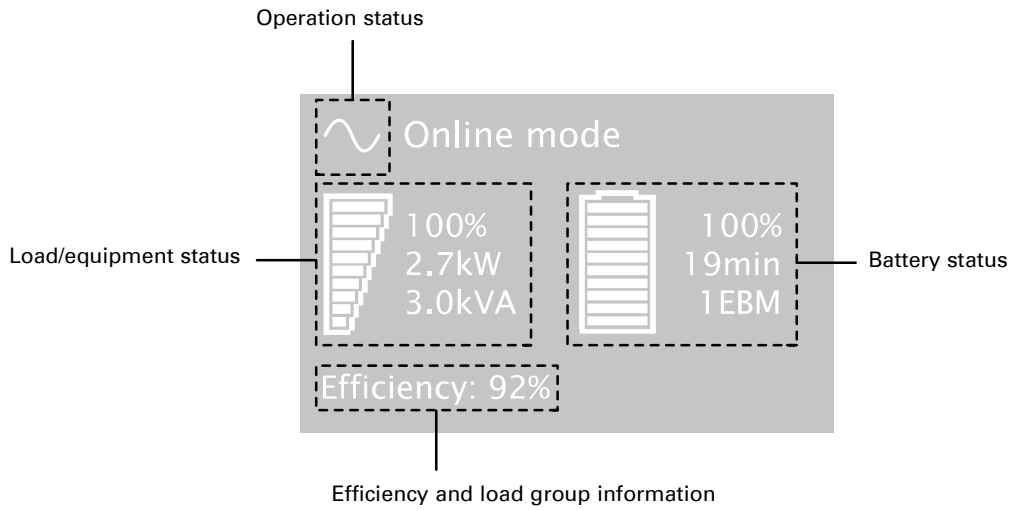

After 5 minutes of inactivity, the LCD displays the screen saver.

The LCD backlight automatically dims after 10 minutes of inactivity. Press any button to restore the screen.



The following table describes the status information provided by the UPS.

Note: If other indicator appears, see troubleshooting on page 34 for additional information.

Operation status	Cause	Description
 Standby mode	The UPS is Off, waiting for start-up command from user.	Equipment is not powered until  button is pressed.
 Online mode	The UPS is operating normally.	The UPS is powering and protecting the equipment.
 Battery mode 1 beep every 10 seconds	A utility failure has occurred and the UPS is on Battery mode.	The UPS is powering the equipment with the battery power. Prepare your equipment for shutdown.
 End of backup time 1 beep every 3 seconds	The UPS is on Battery mode and the battery is running low.	This warning is approximate, and the actual time to shutdown may vary.
 High Efficiency mode	The UPS is operating on High Efficiency mode.	The UPS is powering and protecting the equipment.
 Bypass mode	An overload or a fault has occurred, or a command has been received, and the UPS is on Bypass mode.	Equipment is powered but not protected by the UPS.

4. Interfaces and Communication

4.3 Display functions

Press the Enter (↵) button to activate the menu options. Use the two middle buttons (▲ and ▼) to scroll through the menu structure. Press the Enter (↵) button to select an option. Press the ESC button to cancel or return to the previous menu.

Main menu	Submenu	Display information or Menu function
Measurements		[Load] W VA A pf / [Input/Output] V Hz / [Efficiency] % / [Battery] % min V n° [Battery remaining life] months / [Average power usage] Wh / [Cumulated power] Wh
Control	Go to Bypass	Transfers the UPS on Bypass mode
	Load segments On/Off	Commands the load segments
	Start battery test	Starts a manual battery test
	Connectivity test	Tests dry contact relay outputs and relay card contacts. Simulates line failure and battery low
	Function reset	Clears active fault, power usage, battery remaining life, reset NMC, Restore factory settings
Settings	Local settings	Sets product general parameters
	In/Out settings	Sets Input and Output parameters
	On/Off settings	Sets On/Off conditions
	Battery settings	Sets battery configuration
	Com settings	Sets communication parameters
Event log	Event filter	Selects faults, alarms and/or events to display
	Event list	Displays the events stored
	Reset event list	Clears events
Fault log	Fault list	Displays the faults stored
	Reset fault list	Clears faults
Identification		[Product type/model] / [Part/Serial number] / [UPS/NMC firmware] / [Com card IPv4], [Com card IPv6], [Com card MAC]
Registration		Links to Eaton registration website

4.4 User settings

The following table displays the options that can be changed by the user.

	Submenu	Available settings	Default settings	
Local settings	Language	[English] [Français] [Español] [Português] [Simplified Chinese] [Italiano] [Deutsch] [Русский] [Japanese] Menus, status, notices and alarms, UPS fault, Event Log data and settings are in all supported languages.	[English] Automatic message for user configuration when UPS is powered for the first time.	
	Date / time	Format: [International] [US]	[US]	
	LCD	Modify LCD screen brightness and contrast to be adapted to room light conditions.		
	Audible alarm	[Enabled] [Disabled on battery] [Always disabled] Enable or disable the buzzer if an alarm occurs.		[Enabled]
		Level: [High] [Low]		[High]
Protected access	[Enabled] [Disabled] Password is: 0577		[Disabled]	

4. Interfaces and Communication

	Submenu	Available settings	Default settings
In/Out settings	Output voltage	[200V] [208V] [220V] [230V] [240V]	[230V]
	Output frequency	Mode: [Normal] [Converter] [Marine] Frequency can be changed in Frequency [Converter] mode In [Marine] mode output frequency follows input frequency	[Normal]
	Output mode	Mode: [Industrial] [IT] [Custom] Overload: [Inv>Stop] [Inv>BP] [Inv>BP>Inv] Short-circuit: [Inv>Stop] [Inv>BP] [Inv>BP>Inv]	[IT] [Inv>BP>Inv] [Inv>Stop]
	Input volt hysteresis	Sets input voltage hysteresis from [1] to [10V]	[10V]
	High Efficiency mode	[Enabled] [Disabled] Power the output from Bypass for high efficiency	[Disabled]
	Bypass settings	[Volt low] [Volt high] [Qualify] [Hz synch] [Unsynch]	[160V]; [276V]; [In spec]; [5%]; [Half cycle]
	Load segments	[Auto start delay] [Auto shutdown delay]	UPS: [0s]; Group1: [3s]; Group2: [6s] UPS: [Disabled]; Group1: [Disabled]; Group2: [Disabled]
	Overload prealarm	[10%] ... [102%] Load % when overload alarm occurs	[102%]
	On/Off settings	Start/Restart	[Cold start] [Auto restart] [Auto start] [Start on bypass]
Forced reboot		[Enabled] [Disabled] [Timer] [10s] ... [180s] When mains recover during a shutdown sequence: If set to Enabled, shutdown sequence will complete and wait 10 seconds prior to restart. If set to Disabled, shutdown sequence will not complete, UPS stays on.	[Enabled] [10s]
Energy saving		[Enabled] [Disabled] [Time] [1min] ... [15min] [Level] [100W] ... [1000W] If Enabled, UPS will shut-down after defined duration. Of back-up time, if load is less than set value.	[Disabled] [5min] [100W]
Sleep mode		[Enabled] [Disabled] [Timer] [10min] ... [120min] If Disabled, LCD and communication will turn OFF immediately after UPS is OFF. If Enabled, LCD and communication stays ON 1h30 min after UPS is OFF.	[Enabled] [90min]
Site wiring fault		[Enabled] [Disabled] Prevents from starting the UPS in case of phase vs neutral wires swapping or improper grounding.	[Disabled]
Power Off alert		[Enabled] [Disabled] If Enabled, activates a confirmation screen that requires user confirmation after pressing the power button, before the UPS shutdown occurs.	[Enabled]

	Submenu	Available settings	Default settings
Battery settings	Automatic battery test	In ABM® cycling mode: [No test] [Every ABM® cycle] In constant charge mode: [No test] [Every day] [Every week] [Every month]	[Every ABM® cycle] [Every week]
	Low battery warning	[Capacity] [0%] ... [100%] [Runtime] [0min] ... [60min] The alarm triggers when the set percentage of battery capacity or remaining back-up time is reached.	[0%] [3min]
	Restart bat. level	[0%] ... [100%] If set, automatic restart will occur only when percentage of battery charge is reached.	[0%]
	Battery charge mode	[ABM® cycling] [Constant charge]	[ABM® cycling]
	External battery	[Auto detection] [Manual EBM set.] [Manual battery set.]	[Auto detection] Using standard EBM, UPS detects automatically the number of EBM connected
	Deep Disch. protect.	[Yes] [No] If set to Yes, the UPS automatically prevents battery from deep discharge by adapting end of back-up time voltage threshold. Warranty void if set to No.	[Yes]
Com settings	Input signals	[RPO] [DB9-4] Sets Input signals parameters (function, delay, operation) through external contact connectors or RS232 port. RPO port: - [Function]: [No] [ROO] [RPO] [Building alarm] [Forced bypass] [On generator] [Remote shutdown] - [Delay]: [0s] ... [999s] - [Active]: [Open] [Closed] DB9-4 port: - [Function]: [No] [ROO] [RPO] [Building alarm] [Forced bypass] [On generator] [Remote shutdown] - [Delay]: [0s] ... [999s] - [Active]: [High] [Low]:	[No] [0s] [Open] [No] [0s] [High]

4. Interfaces and Communication

	Submenu	Available settings	Default settings
Com settings	Output signals	<p>[Relay] [DB9-1] [DB9-8] Sets events or fault that will actuate Output signal parameters through external contact connector or RS232 port</p> <p>[Relay]: [On bat] [Low bat] [Bat fault] [Bypass] [UPS OK] [Load protected] [Load powered] [General alarm] [Ext. charger ON] [OVL pre-alarm]</p> <p>[DB9-1]: [On bat] [Low bat] [Bat fault] [Bypass] [UPS OK] [Load protected] [Load powered] [General alarm] [Ext. charger ON] [OVL pre-alarm]</p> <p>[DB9-8]: [On bat] [Low bat] [Bat fault] [Bypass] [UPS OK] [Load protected] [Load powered] [General alarm] [Ext. charger ON] [OVL pre-alarm]</p>	<p>[Relay] [Bypass]</p> <p>[DB9-1] [Low bat]</p> <p>[DB9-8] [On bat]</p>
	Remote command	<p>[Enabled] [Disabled] If Enabled, shutdown or restart commands from software are authorized.</p>	[Enabled]
	Shutdown commands	<p>[Send CMD] [Output OFF] [OFF delay] [restart] Sets events or fault that will actuate Output signal parameters through external contact connector or RS232 port</p> <p>[Send CMD]: [Yes] [No] [Output OFF]: [No] [UPS] [Group 1] [Group 2] [Group 1 + Group 2] [OFF delay]: [0s] ...[999s] [Restart]: [Yes] [No]</p> <p>For a proper server shutdown please make sure that the Output OFF delay is long enough</p>	<p>Send CMD: [No] Output OFF: [No]</p> <p>OFF delay: [0s] Restart: [Yes]</p>
	On battery notice delay	<p>[0s] ... [99s] Sets delay before noticing on battery information to software.</p>	[0s]
	General alarm	<p>[On battery] [Battery fault] [Overload pre-alarm] [Internal fault] [Ambient temp.] [Fan lock] [Bypass overload] [Current limit] [Short circuit] [Inverter overload] [Power overload] [Low battery] [On bypass] [UPS OK] [Load protected] [Load powered] [Ext. charger ON] Defines which event or fault generate a general alarm through Output signal screen.</p>	[Internal fault]

4. Interfaces and Communication

4.5 Communication ports

Connection of RS232 or USB communication port

Independent	Multiplexed	
	USB	RS-232
Communication Bay	Available	Not in use
Any connectivity card	Not in use	Available

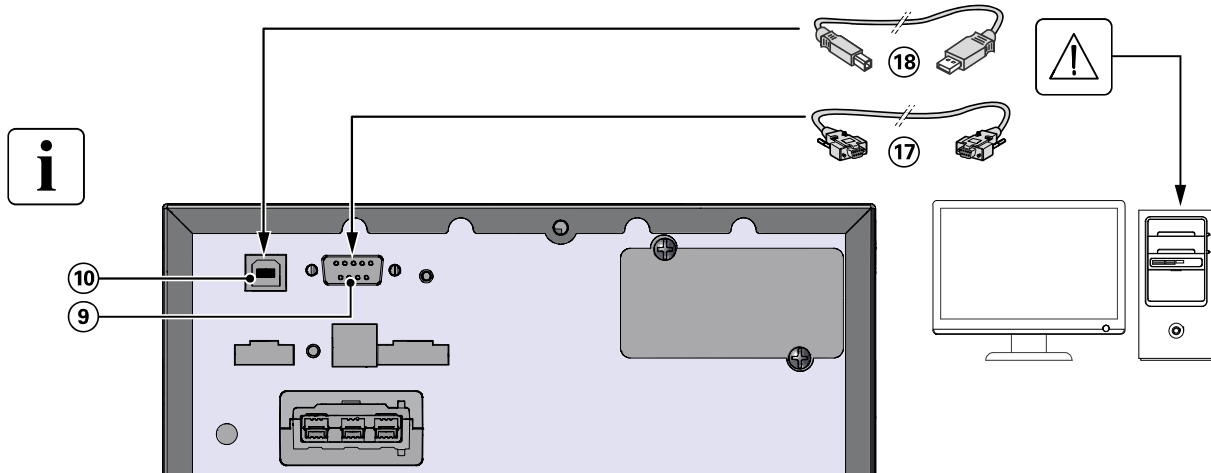

1. Connect the RS232 (17) or USB (18) communication cable to the serial or USB port on the computer equipment.
2. Connect the other end of the communication cable (17) or (18) to the USB (10) or RS232 (9) communication port on the UPS.

The **UPS** can now communicate with EATON power management software.

Characteristics of the contact RS232 communication port

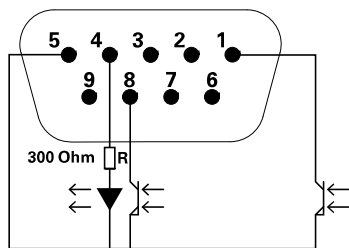

Contact characteristics (optocoupler)

- Voltage: 48 V DC max
- Current: 25 mA max

Pin	Signal	Direction	Function
1	Bat Low	Output	Low Battery Output
2	TxD	Output	Transmit to external device
3	RxD	Input	Receive from external device
4	I/P SIG	Input	-
5	GNDS	-	Signal Common tied to chassis
6	PNP	Input	Plug and Play
7			Not used
8	BAT Mode	Output	-
9	+5V	Output	Power supply for external signal or options

4. Interfaces and Communication

4.6 UPS remote control functions

Programmable Signal Inputs

The 9SX incorporates 2 programmable signal inputs: one RPO terminal input, one RS-232 input (pin-4). Signal inputs can be configured (see User settings > Com settings > Signal Input on page 21) to have one of the following functions:

Function	Description
No	No function, please choose a function if you want to use input signal
RPO	Remote Power off (RPO) is used to shutdown the UPS remotely
ROO	Remote On/Off allows remote action of button to switch On/Off the UPS. (Cold start is prohibited while using the ROO function)
Forced bypass	If feeding the load the unit goes to bypass operation and stays there regardless of the bypass state until the input is inactivated
Building alarm	Active input generates an alarm "building alarm"
On generator	Active input disables synchronization and transfers to bypass
Remote shutdown	Active input turns UPS output (or outlet groups) off after a user defined shutdown delay but keeps on charging batteries according to a selected charging scheme, inactive input does not abort shutdown countdown. Depending on the "Restart" parameter (see User settings > Com Settings > Shutdown commands on page 22) the unit may startup automatically.



Warning Signal inputs have no function by default please choose a function through the LCD (User Settings > Com settings > Input signals on page 21).

See below example of configuration with RPO terminal used as RPO function:

- **Remote Power Off (RPO)**

RPO is used to shutdown the UPS remotely when the contact is open. This feature can be used for shutting down the load and the UPS by thermal relay, for instance in the event of room over temperature. When RPO is activated, the UPS shuts down the output and all its power converters immediately. The UPS remains on to alarm the fault.

The RPO circuit is an IEC 60950 safety extra low voltage (SELV) circuit. This circuit must be separated from any hazardous voltage circuits by reinforced insulation.

- The RPO must not be connected to any utility connected circuits. Reinforced insulation to the utility is required. The RPO switch must be a dedicated latching-type switch not tied into any other circuit. The RPO signal must remain active for at least 250 ms for proper operation.
- To ensure the UPS stops supplying power to the load during any mode of operation, the input power must be disconnected from the UPS when the Remote Power Off function is activated.

Leave the RPO connector installed in the RPO port on the UPS even if the RPO function is not needed.

RPO connections:

RPO	Comments
Connector type	Terminal, 14 AWG Maximum wires
External breaker specification	60 V DC/30 V AC 20 mA max

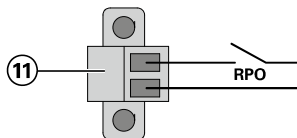

4. Interfaces and Communication

- **Remote control connection and test**

1. Check the UPS is shut down and the electrical supply network disconnected.
2. Remove RPO connector from the UPS by unfitting the screws.
3. Connect a normally closed volt-free contact between the two pins of connector.

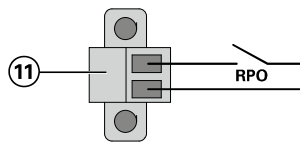

Contact open: shut down of UPS.

To return to normal operation, deactivate the external remote shut down contact and restart the UPS from the front panel.

Normally closed

4. Plug the RPO connector into the back of the UPS and fix the screws.
5. Connect and restart the UPS according to the previously described procedures.
6. Activate the external remote shut down contact to test the function.

Always test the RPO function before applying your critical load to avoid accidental load loss.

Programmable Signal Outputs

The 9SX incorporates 3 programmable signal outputs: one relay output, 2 optocouplers outputs (pin-1/8). Signal outputs can be configured (see User Settings > Com settings > Output Signals on page 22) to report the following information:

Signal	Default assignment	Description
On battery (On bat)	DB9-Pin 8	UPS is in battery mode
Low battery (Low bat)	DB9-Pin 1	Battery is nearly empty
Battery fault (Bat fault)	-	Battery fault
Bypass	Relay output ⁽¹⁾	UPS is operating in Bypass mode
Load powered	-	Load is powered (from inverter or bypass)
Load protected	-	UPS is on inverter, with no alarm and ready to go to battery
General alarm	-	Choose events that will trigger this alarm through the LCD (User settings > Com settings > General alarm) for more information on possible events please look at page 22.
Ext charger ON	-	Control an optional external battery charger on and off.
OVL pre-alarm	-	Overload pre-alarm

(1) Relay output:

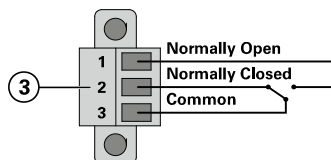

4. Interfaces and Communication

Connectivity Cards

Connectivity cards allow the UPS to communicate in a variety of networking environments and with different types of devices. The 9SX models have one available communication bay for the following connectivity cards:

- **Network-MS card** - has SNMP and HTTP capabilities as well as monitoring through a Web browser interface; connects to Ethernet network. In addition, an Environmental Monitoring Probe can be attached to obtain humidity, temperature, smoke alarm, and security information.
- **Network-M2 card** - provides a Gigabit Ethernet connection and enables secure UPS monitoring over HTTPS web browser interface, SNMP v1/v3 protocol and email alarms. In addition, up to 3 Environmental Monitoring Probes can be attached to obtain humidity, temperature, smoke alarm, and security information.
- **Modbus-MS card** - has connection to Modbus protocol in addition to network management.
- **INDGW-M2 Industrial Gateway card** - provides Modbus TCP and 2/4 wire Modbus RTU communications in addition to all the features of the Gigabit network card (Network-M2).
- **Relay-MS card** - has isolated dry contact (Form-C) relay outputs for UPS status: Utility failure, Battery low, UPS alarm/OK, or on Bypass.
- **INDRELAY-MS card** - has isolated dry contact relay outputs rated for 250Vac/8A for UPS status: Utility failure, Battery low, UPS alarm/OK, or on Bypass. It has terminal block connectors.

Installation of the communication cards (optional)

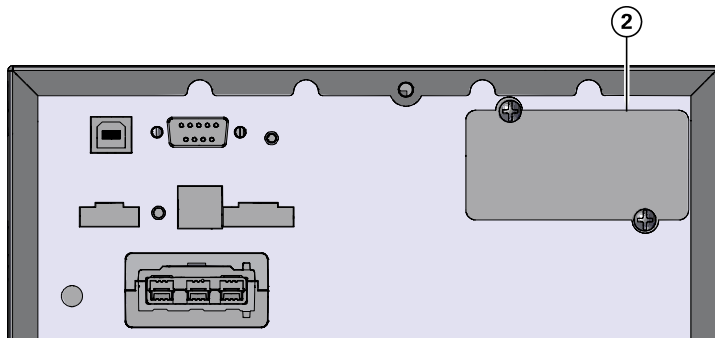

It is not necessary to shutdown the UPS before installing a communication card.

1. Remove the slot cover ② secured by screws.
2. Insert the communication card in the slot.
3. Secure the card cover with the 2 screws.

4.7 Eaton Intelligent Power Software suite

Eaton Intelligent Power Software suite is available from eaton.com/downloads.

Eaton Software suite provides up-to-date graphics of UPS power and system data and power flow.

It also gives you a complete record of critical power events, and it notifies you of important UPS or power information.





If there is a power outage and the 9SX UPS battery power becomes low, Eaton Software suite can automatically shut down your computer system to protect your data before the UPS shutdown occurs.

4.8 Cybersecurity

Eaton is committed to minimizing the Cybersecurity risk in its products and deploys cybersecurity best practices and latest cybersecurity technologies in its products and solutions, making them more secure, reliable and competitive for our customers. Eaton also offers Cybersecurity Best Practices whitepapers to its customers, referenced at www.eaton.com/cybersecurity.

5.1 Start-up and Normal operation

To start the UPS:



1. Verify that the UPS power cord is plugged in and upstream circuit breaker is turned on.
2. The UPS front panel display illuminates and shows EATON logo.
3. Verify that the UPS status screen shows .
4. Press the  button on the UPS front panel for at least 2 seconds.
The UPS front panel display changes status to "UPS starting...".
5. Check the UPS front panel display for active alarms or notices. Resolve any active alarms before continuing. See "Troubleshooting" on page 34.
If the  indicator is on, do not proceed until all alarms are clear. Check the UPS status from the front panel to view the active alarms. Correct the alarms and restart if necessary.
6. Verify that the  indicator illuminates solid, indicating that the UPS is operating normally and any loads are powered and protected.
The UPS should be in Normal mode.

5.2 Starting the UPS on Battery





Before using this feature, the UPS must have been powered by utility power with output enabled at least once. Battery start can be disabled. See the "Cold start" setting in "ON/OFF Settings" on page 20.

To start the UPS on battery:

1. Press the  button on the UPS front panel until the UPS front panel display illuminates and shows a status of "UPS starting...".
The UPS transfers from Standby mode to Battery mode. The  indicator illuminates solid. The UPS supplies power to your equipment.
2. Check the UPS front panel display for active alarms or notices besides the "Battery mode" notice and notices that indicate missing utility power. Resolve any active alarms before continuing. See "Troubleshooting" on page 34.
Check the UPS status from the front panel to view the active alarms. Correct the alarms and restart if necessary.

5.3 UPS Shutdown

To shut down the UPS:

1. Press the  button on the front panel for 3 seconds.
A confirmation message will appear.
When confirmed, the UPS starts to beep and shows a status of "UPS shutting OFF..". The UPS then transfers to Standby mode, and the  indicator turns off.

5.4 Operating modes

The Eaton 9SX front panel indicates the UPS status through the UPS indicators, see page 17.

Online mode

During Online mode, the  indicator illuminates solid and the UPS is powered from the utility.

The UPS monitors and charges the batteries as needed and provides filtered power protection to your equipment. Optional High Efficiency and Energy Saving settings minimize heat contribution to the environment. See user settings on page 19.

Battery mode

When the UPS is operating during a power outage, the alarm beeps once every 10 seconds and the  indicator illuminates solid. The necessary energy is provided by the battery.

When the utility power returns, the UPS transfers to Online mode operation while the battery recharges.

If battery capacity becomes low while on Battery mode, the audible alarm beeps once every 3 seconds.

This warning is approximate, and the actual time to shutdown may vary significantly.

Shutdown all applications on the connected equipment because automatic UPS shutdown is imminent.

When utility power is restored after the UPS shuts down, the UPS automatically restarts.

5. Operation

Low-battery warning



- The  indicator illuminates solid.
- The audio alarm beeps every three seconds.

The remaining battery power is low. Shut down all applications on the connected equipment because automatic UPS shutdown is imminent.

End of battery backup time

- LCD displays "End of backup time".
- All the LEDs go OFF.
- The audio alarms stops.

Bypass mode

In the event of a UPS overload or internal failure, the UPS transfers your equipment to utility power. Battery mode is not available and your equipment is not protected; however, the utility power continues to be passively filtered by the UPS. The  indicator illuminates.

Depending on overload conditions, the UPS remains in Bypass mode for at least 5 seconds and will stay in this mode if three transfers to Bypass occur within 20 minutes.

The UPS transfers to Bypass mode when:

- the user activates Bypass mode through the front panel,
- the UPS detects an internal failure,
- the UPS has an over temperature condition,
- the UPS has an overload condition listed in table 6 on page 38.



The UPS shuts down after a specified delay for overload conditions listed in table 6 on page 38. The UPS remains on to alarm the fault.

5.5 Return of AC Input Power

Following an outage, the UPS restarts automatically when AC input power returns (unless the restart function has been disabled) and the load is supplied again.

5.6 Setting High Efficiency mode

In High Efficiency mode, the UPS operates normally on Bypass and transfers to Online (or Battery) mode in less than 10 ms when utility fails. Transfers to High Efficiency mode will be active after 5 minutes of Bypass voltage monitoring: if Bypass quality is not in tolerance, then the UPS will remain in Online mode.



Eaton recommends to use the HE mode only to protect IT equipment.

To set the High Efficiency mode:

1. Select Settings, In/Out settings, and High Efficiency mode.
2. Select Enabled and Enter to confirm.
3. The UPS transfers to High Efficiency mode after 5 minutes.

5.7 Configuring Bypass settings

The following settings are available for configuring Bypass operation.

Bypass Voltage Low Limit

The default disables a transfer to Bypass if the measured bypass voltage level is below the nominal output voltage minus 20%. You can configure the setting for another voltage value. This setting can be overruled by the "Qualify Bypass" setting.

Bypass Voltage High Limit

The default disables a transfer to Bypass if the measured bypass voltage level is above the nominal output voltage plus 15%. You can configure the setting for another voltage value. This setting can be overruled by the "Qualify Bypass" setting.

Qualify Bypass

The default setting ("In spec") allows a transfer to Bypass only when Bypass is within the following specifications:

- Bypass voltage is between the "Bypass Voltage Low Limit" and "Bypass Voltage High Limit" settings.
- Bypass frequency is within nominal frequency 5%.

You can prohibit Bypass ("Never") or always allow Bypass with no specification checking ("Always"). For "Always on UPS Fault," transfer to Bypass is always made on UPS fault; otherwise, operation proceeds as with the default setting.

Synchronization Window

The UPS tries to synchronize with Bypass when the Bypass frequency is less than the value set for the "Synchronization Window" setting. When the Bypass frequency is more than the set value, the UPS goes to nominal frequency.

Unsynchronized Transfers

When Qualify Bypass is set to "Always" or "Always on Fault" you can select the interruption time when transferring to bypass, default setting is "Half Cycle" but can be changed to "Full cycle".

5.8 Configuring battery settings

Automatic battery test

Automatic battery tests are done every week in constant charging mode and at each cycle in ABM[®] mode. The tests frequency can be modified.

During the test, the UPS transfers to Battery mode and discharges the batteries for 10 seconds under load.



Battery mode is not displayed and battery low alarm does not activate during a battery test.

The battery test may be postponed due to bad conditions, or failed if battery is not ok.

Low battery warning

During discharge, the low battery alarm is activated if the remaining runtime goes below 3 minutes or less than the setting capacity threshold (0% by default).

This threshold can be modified.

External battery setting

The number of Extended Battery Module is automatically detected, or can be set manually in number of EBM or in Ah.

Deep discharge protection

This setting is recommended to avoid damaging the battery. Warranty is void if deep discharge protection is disabled.

5.9 Retrieving the Event log

To retrieve the Event log through the display:

1. Press any button to activate the menu options, then select Event log.
2. Scroll through the listed events.

5.10 Retrieving the Fault log

To retrieve the Fault log through the display:

1. Press any button to activate the menu options, then select Fault log.
2. Scroll through the listed faults.

6. UPS maintenance

6.1 Equipment care

For the best preventive maintenance, keep the area around the equipment clean and dust free. If the atmosphere is very dusty, clean the outside of the system with a vacuum cleaner. For full battery life, keep the equipment at an ambient temperature of 25 °C (77 °F).



If the UPS requires any type of transportation, verify that the UPS is disconnected and turned off. The batteries are rated for a 3-5 year service life. The length of service life varies, depending on the frequency of usage and ambient temperature (life divided by 2 each 10 °C above 25 °C). Batteries used beyond expected service life will often have severely reduced runtimes. Replace batteries at least every 4 years to keep units running at peak efficiency. Batteries runtime will be reduced at low temperature (below 10 °C).

6.2 Storing the equipment

If you store the equipment for a long period, recharge the battery every 6 months by connecting the UPS to utility power. The internal batteries charge to 90% capacity in less than 3 hours. However, Eaton recommends that the batteries charge for 24 hours after long-term storage. Check the battery recharge date on the shipping carton label. If the date has passed and the batteries were never recharged, do not use them. Contact your service representative.

6.3 When to replace batteries

Eaton UPS batteries have an expected life span of 3-5 years. After 4 years of operation, the UPS will provide a battery replacement notification reminding you that your batteries are nearing the end of their useful life. You should take proactive steps to ensure you replace your batteries for optimal operation and reliability. Contact your service representative to order new batteries. Battery recommended replacement date can be accessed through the LCD (Measurements > Battery).



6.4 Replacing batteries



DO NOT DISCONNECT the batteries while the UPS is in Battery mode.

Batteries can be replaced easily without turning off the UPS or disconnecting the load. If you prefer to remove input power to change the batteries, see "UPS Shutdown" on page 27.



Consider all warnings, cautions, and notes before replacing batteries.

- Servicing should be performed by qualified service personnel knowledgeable of batteries and required precautions. Keep unauthorized personnel away from batteries.
- Batteries can present a risk of electrical shock or burn from high short circuit current. Observe the following precautions:
 1. Remove watches, rings, or other metal objects.
 2. Use tools with insulated handles.
 3. Do not lay tools or metal parts on top of batteries.
 4. Wear rubber gloves and boots.
- When replacing batteries, replace with the same type and number of batteries or battery packs. Contact your service representative to order new batteries.
- Proper disposal of batteries is required. Refer to your local codes for disposal requirements.
- Never dispose of batteries in a fire. Batteries may explode when exposed to flame.
- Do not open or mutilate the battery or batteries. Released electrolyte is harmful to the skin and eyes and may be extremely toxic.
- Determine if the battery is inadvertently grounded. If inadvertently grounded, remove source from ground. Contact with any part of a grounded battery can result in electrical shock. The likelihood of such shock can be reduced if such grounds are removed during installation and maintenance (applicable to equipment and remote battery supplies not having a grounded supply circuit).
- **ELECTRIC ENERGY HAZARD.** Do not attempt to alter any battery wiring or connectors. Attempting to alter wiring can cause injury.
- Disconnect charging source prior to connecting or disconnecting battery terminals.

6. UPS maintenance

- Replacing the internal battery - TOWER 0-3KVA



The internal battery is heavy. Use caution when handling heavy batteries.
To replace the battery pack:

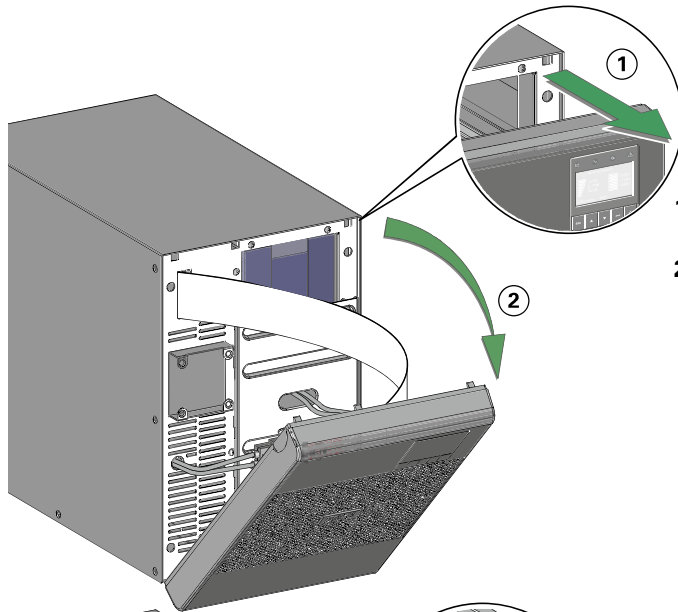

1. Unlock the lugs on the upper part of the front panel.
2. Rotate the front face.

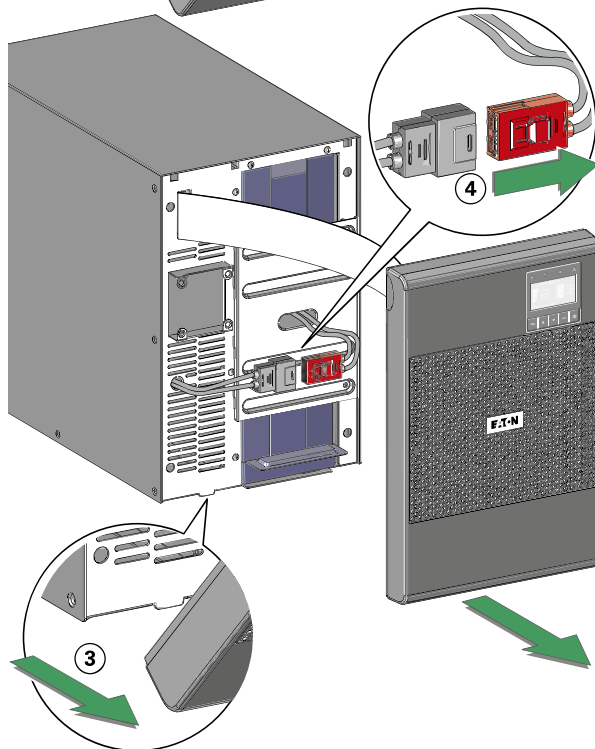

3. Remove the lower part of the front panel.



A ribbon cable connects the LCD control panel to the UPS. Do not pull on the cable or disconnect it.

4. Disconnect the internal battery connector.

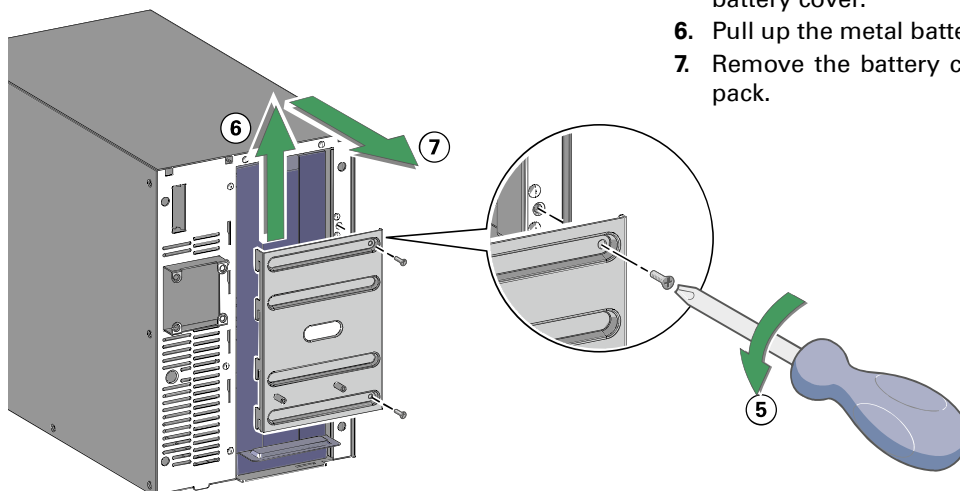

5. Unscrew and remove the 2 screws of the metal battery cover.
6. Pull up the metal battery protection cover.
7. Remove the battery cover to free the battery pack.

6. UPS maintenance

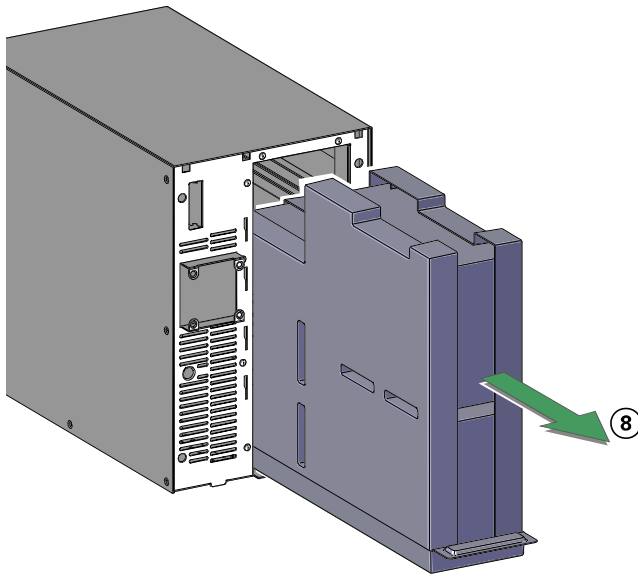

8. Pull out the plastic handle of the battery pack, and slide the pack out slowly on to a flat and stable surface. Use two hands to support the battery pack. See "Recycling the used equipment" on page 33 for proper disposal.
9. Verify that the replacement batteries have the same rating as the batteries being replaced.
- 10 Put the new battery pack into the UPS. Push the battery pack firmly to ensure a proper connection.
11. Reassemble in the reverse order.
12. Continue to "Testing new batteries" on page 33.
13. Reset the 4 years Life Cycling Monitoring (LCM): Control > Reset battery life.

• Replacing the EBM(s) (all models)



The EBM is heavy (see page 8), handling requires a minimum of 2 people.

To replace the EBM(s):

1. Unplug the EBM power cable and battery detection cable from the UPS.
If additional EBM(s) are installed, unplug the EBM power cable and battery detection cable from each EBM.
2. Replace the EBM(s). See "Recycling the used equipment" on page 33 for proper disposal.



A small amount of arcing may occur when connecting an EBM to the UPS. This is normal and will not harm personnel. Insert the EBM cable into the UPS battery connector quickly and firmly.

3. Plug the EBM cable(s) into the battery connector(s). Up to four EBMs may be connected to the UPS.
4. Verify that the EBM connections are tight and that adequate bend radius and strain relief exist for each cable.
5. Connect the battery detection cable(s) to the connector of the UPS and of the EBM(s).

• Testing new batteries

To test new batteries:

1. Charge the batteries for 48 hours.
2. Press any button to activate the menu options.
3. Select Control then Start battery test.

The UPS starts a battery test if the batteries are fully charged, the UPS is in Normal mode with no active alarms, and the bypass voltage is acceptable.

During the battery test, the UPS transfers to Battery mode and discharges the batteries for 10 seconds. The front panel displays "Battery test in progress" and the percentage of the test completed.

6.5 Recycling the used equipment

Contact your local recycling or hazardous waste center for information on proper disposal of the used equipment.



- Do not dispose of the battery or batteries in a fire. Batteries may explode. Proper disposal of batteries is required. Refer to your local codes for disposal requirements.
- Do not open or mutilate the battery or batteries. Released electrolyte is harmful to the skin and eyes. It may be toxic.



Do not discard the UPS or the UPS batteries in the trash. This product contains sealed, lead acid batteries and must be disposed of properly. For more information, contact your local recycling/reuse or hazardous waste center.



Do not discard waste electrical or electronic equipment (WEEE) in the trash. For proper disposal, contact your local recycling/reuse or hazardous waste center.

7. Troubleshooting

The Eaton 9SX are designed for durable, automatic operation and also alert you whenever potential operating problems may occur. Usually the alarms shown by the control panel do not mean that the output power is affected. Instead, they are preventive alarms intended to alert the user.

- Events are silent status information that are recorded into the Event log. Example = "AC freq in range".
- Alarms are recorded into the Event log and displayed on the LCD status screen with the logo blinking. Some alarms may be announced by a beep every 3 seconds. Example = "Battery low".
- Faults are announced by a continuous beep and red LED, recorded into the Fault log and displayed on the LCD with a specific message box. Example = Out. short circuit.



Use the following troubleshooting chart to determine the UPS alarm condition.



7.1 Typical alarms and faults

To check the Event log or Fault log:

1. Press any button on the front panel display to activate the menu options.
2. Press the ▼ button to select Event log or Fault log.
3. Scroll through the listed events or faults.

The following table describes typical conditions.

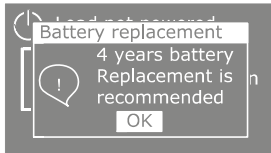
Conditions	Possible cause	Action
 Battery mode LED is On. 1 beep every 10 seconds.	A utility failure has occurred and the UPS is in Battery mode.	The UPS is powering the equipment with battery power. Prepare your equipment for shutdown.
 Battery low LED is On. 1 beep every 3 seconds.	The UPS is in Battery mode and the battery is running low.	This warning is approximate, and the actual time to shutdown may vary significantly. Depending on the UPS load and number of Extended Battery Modules (EBMs), the "Battery Low" warning may occur before the batteries reach 20% capacity.
 No battery LED is On. Beep continuous.	The batteries are disconnected.	Verify that all batteries are properly connected. If the condition persists, contact your service representative.
 Battery fault LED is On. Beep continuous.	The battery test is failed due to bad or disconnected batteries, or the battery minimum voltage is reached in ABM® cycling mode.	Verify that all batteries are properly connected. Start a new battery test: if the condition persists, contact your service representative.
The UPS does not provide the expected backup time.	The batteries need charging or service.	Apply utility power for 48 hours to charge the batteries. If the condition persists, contact your service representative.
 Bypass mode LED is on.	An overload or a fault has occurred, or a command has been received and the UPS is in Bypass mode.	Equipment is powered but not protected by the UPS. Check for one of the following alarms: overtemperature, overload or UPS failure.
 Power overload LED is On. Beep continuous.	Power requirements exceed the UPS capacity (greater than 100% of nominal; see in table 6 on page 38 for specific output overload ranges).	Remove some of the equipment from the UPS. The UPS continues to operate, but may switch to Bypass mode or shut down if the load increases. The alarm resets when the condition becomes inactive.

 <p>UPS overtemperature</p> <p>LED is On. 1 beep every 3 seconds.</p>	<p>The UPS internal temperature is too high or a fan has failed.</p> <p>At the warning level, the UPS generates the alarm but remains in the current operating state.</p> <p>If the temperature rises another 10 °C, the UPS transfers to Bypass mode or shuts down if Bypass is unusable.</p>	<p>If the UPS transferred to Bypass mode, the UPS will return to normal operation when the temperature drops 5 °C below the warning level.</p> <p>If the condition persists, shut down the UPS.</p> <p>Clear vents and remove any heat sources. Allow the UPS to cool. Ensure the airflow around the UPS is not restricted. Restart the UPS.</p> <p>If the condition continues to persist, contact your service representative.</p>
<p>The UPS does not start.</p>	<p>The input source is not connected correctly.</p>	<p>Check the input connections.</p>
	<p>After 4 years of operation, the UPS will provide a battery replacement notification reminding you that your batteries are nearing the end of their useful life.</p>	<p>See "6.3 When to replace batteries".</p>
 <p>Site Wiring Fault</p> <p>LED is On. 1 beep every second.</p>	<p>Ground wire connection does not exist, or the line and neutral wires are reversed in the wall outlet.</p> <p>(Except for models 9SX1000G / 9SX1500G / 9SX2000G / 9SX3000G / 9SX3000GL where there is no neutral).</p>	<p>Have a qualified electrician correct the wiring.</p> <p>(For models 9SX1000G / 9SX1500G / 9SX2000G / 9SX3000G / 9SX3000GL disable the Site Wiring Fault Alarm setting, see "User Settings" on page 19).</p>

7.2 Silencing the alarm

Press the ESC (Escape) button on the front panel display to silence the alarm. Check the alarm condition and perform the applicable action to resolve the condition. If the alarm status changes, the alarm beeps again, overriding the previous alarm silencing.

7.3 Service and support

If you have any question or problem with the UPS, call your distributor, your local service representative or connect to: powerquality.eaton.com.

Please have the following information ready when you call for service:

- Model number
- Serial number
- Firmware version number
- Date of failure or problem
- Symptoms of failure or problem
- Customer return address and contact information

If repair is required, you will be given a Returned Material Authorization (RMA) number. This number must appear on the outside of the package and on the Bill Of Lading (if applicable). Use the original packaging or request packaging from the Help Desk or distributor. Units damaged in shipment as a result of improper packaging are not covered under warranty. A replacement or repair unit will be shipped, freight prepaid for all warranted units.



For critical applications, immediate replacement may be available. Call the **Help Desk** for the dealer or distributor nearest you.

7.4 CE compliance contact

- Eaton I.F. SAS - 110 Rue Blaise Pascal - 38330 Montbonnot St Martin – France.

8. Specifications

8.1 Model specifications

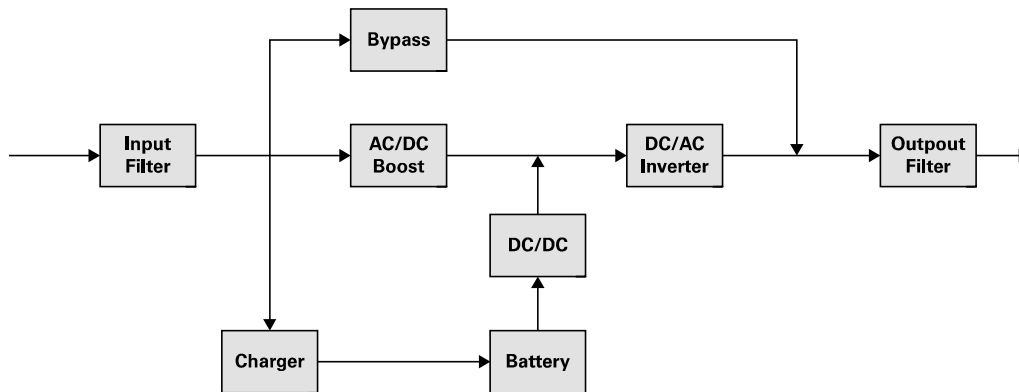

Table 1. Power Module model list

Description	Catalog Number	Power ratings
Eaton 9SX 700 120V Tower	9SX700	700VA / 630W
Eaton 9SX 1000 120V Tower	9SX1000	1000VA / 900W
Eaton 9SX 1500 120V Tower	9SX1500	1500VA / 1350W
Eaton 9SX 2000 120V Tower	9SX2000	1960VA / 1770W
Eaton 9SX 3000 120V Tower	9SX3000	3000VA / 2700W
Eaton 9SX 3000 120V Tower HW	9SX3000HW	3000VA / 2700W
Eaton 9SX 1000G 208V Tower	9SX1000G	1000VA / 900W
Eaton 9SX 1500G 208V Tower	9SX1500G	1500VA / 1350W
Eaton 9SX 2000G 208V Tower	9SX2000G	2000VA / 1800W
Eaton 9SX 3000G 208V Tower	9SX3000G	3000VA / 2700W
Eaton 9SX 3000GL 208V Tower	9SX3000GL	3000VA / 2700W

Table 2. Extended Battery Module model list

Description	Catalog Number	Configuration	Battery voltage	For power ratings
Eaton 9SX EBM 36V	9SXEBM36	Tower	36Vdc	1000VA
Eaton 9SX EBM 48V	9SXEBM48	Tower	48Vdc	1500VA
Eaton 9SX EBM 96V	9SXEBM96	Tower	96Vdc	2000-3000VA

Table 3. Weights and dimensions

Catalog Number (UPS)	Weights (lb/kg)	Dimensions (inch/mm) D x W x H
9SX700	25.4 / 11.5	357 x 6.3 x 9.9 / 160 x 252 x 357
9SX1000	32.6 / 14.8	387 x 6.3 x 9.9 / 160 x 252 x 387
9SX1500	40.8 / 18.5	387 x 6.3 x 9.9 / 160 x 252 x 437
9SX2000	73.4 / 33.3	412 x 8.4 x 13.6 / 214 x 346 x 412
9SX3000	73.6 / 33.4	412 x 8.4 x 13.6 / 214 x 346 x 412
9SX3000HW	73.9 / 33.5	412 x 8.4 x 13.6 / 214 x 346 x 412
9SX1000G	25.4 / 11.5	387 x 6.3 x 9.9 / 160 x 252 x 387
9SX1500G	32.6 / 14.8	387 x 6.3 x 9.9 / 160 x 252 x 437
9SX2000G	73.4 / 33.3	412 x 8.4 x 13.6 / 214 x 346 x 412
9SX3000G	73.6 / 33.4	412 x 8.4 x 13.6 / 214 x 346 x 412
9SX3000GL	73.6 / 33.4	412 x 8.4 x 13.6 / 214 x 346 x 412
Catalog Number (EBM)	Weights (lb/kg)	Dimensions (mm) D x W x H
9SXEBM36V	41.9 / 19	387 x 6.3 x 9.9 / 160 x 252 x 387
9SXEBM48V	54 / 24.5	387 x 6.3 x 9.9 / 160 x 252 x 387
9SXEBM96V	107.4 / 48.7	412 x 8.4 x 13.6 / 214 x 346 x 412

Table 4. Electrical input

Nominal frequency	50/60Hz auto-sensing		
Frequency range	40-70Hz before transfer to battery		
Bypass voltage range	-20% / +15% of nominal value (default)		
Catalog Number	Default input (Voltage/Current)	Input nominal voltages	Input voltage window
9SX700	120V / 6.5A	100V, 110V, 120V, 125V	at 100% load: 100-144V at ≤25% load: 60-144V
9SX1000	120V / 9.0A		
9SX1500	120V / 12A		
9SX2000	120V / 16A		at 100% load: 100-144V at ≤25% load: 70-144V
9SX3000	120V / 24A		
9SX3000HW	120V / 24A		
9SX1000G	208V / 4.9A	200V, 208V, 220V, 230V, 240V	at 100% load: 190-276V at ≤25% load: 120-276V
9SX2000G	208V / 9.4A		
9SX3000G	208V / 14.42A		at 100% load: 200-276V at ≤25% load: 140-276V
9SX3000GL	208V / 14.42A		

Table 5. Electrical input connections

Catalog Number	Input connection	Input cable
9SX700	NEMA 5-15P	Attached line cord 8ft / 2.4m
9SX1000		
9SX1500		
9SX2000	NEMA 5-20P	Attached line cord 8ft / 2.4m
9SX3000	NEMA L5-30P	Attached line cord 8ft / 2.4m
9SX3000HW	Hardwired	NA
9SX1000G	IEC C14-10A	Customer supplied (1)
9SX1500G		
9SX2000G	IEC C14-10A	IEC320/13A (IEC C13) to L6-20/1.8m (1)
9SX3000G	IEC C20-16A	IEC320/16A (IEC C19) to L6-20/2.4m (2)
9SX3000GL	IEC C20-16A	IEC320/16A (IEC C19) to L6-20/2.4m (2)

(1) If used in 2W + PE configuration, customer should use input power cord IEC C13 to NEMA 6-15P or L6-15P (min18 AWG / 3C , min 300V, 105 °C ,min 1.5 m, max 4.5 m)

(2) If used in 2W + PE configuration, customer should use input power cord IEC C19 to NEMA 6-20P or L6-20P (min14 AWG / 3C , min 300V, 105 °C , min 1.5 m, max 4.5 m)

8. Specifications

Table 6. Electrical output

All models		Normal mode	High Efficiency mode	Battery mode
Voltage regulation		$\pm 2\%$		$\pm 3\%$
Efficiency	9SX700	86%	93%	79,5%
	9SX1000	87%	93%	82%
	9SX1000G	90%	94%	82%
	9SX1500	86%	93%	82%
	9SX1500G	90%	94%	82%
	9SX2000	88%	93%	84%
	9SX2000G	90%	94%	84%
	9SX3000	89%	93%	84%
	9SX3000G	91%	94%	84%
Frequency regulation		Sync with line $\pm 5\%$ of nominal line frequency (outside this range: $\pm 0.5\%$ of auto-selected nominal frequency)		$\pm 0.5\%$ of auto-selected nominal frequency
Nominal output		100 / 110 / 120 / 125 (for 120V models) 200 / 208 / 220 / 230 / 240 (for 208V models)		
Frequency		50 or 60Hz. autosensing or configurable as a frequency converter		
Output overload (Online mode)	102%~130%*		12 seconds	
	130%~150%*		2 seconds	
	>150%*		Shutdown immediately**	
Output overload (Battery mode)	102%~130%*		12 seconds	
	130%~150%*		2 seconds	
	>150%*		Shutdown immediately, overload warning**	
Output overload (Bypass mode)	102%~110%*		Overload warning	
	110%~130%*		Shutdown after 5 minutes	
	130%~150%*		Shutdown after 15 seconds	
	>150%*		Shutdown after 300 ms	
Voltage waveform		Sine wave		
Harmonic distortion		< 3% THDV on linear load < 5% THDV on non-linear load		
Transfer time		Online mode: 0 ms High Efficiency mode: 10 ms maximum (due to loss of utility)		
Power factor		Up to 0.9		
Load crest ratio		Up to 3:1		

* Percent is based on nominal Watt/VA

** Behaviour can change (see output mode in In/Out settings of the section 4.4)

Table 7. Electrical output connection

Catalog Number	Output connection	Output cables
9SX700	(2) NEMA 5-15R	NA
9SX1000	(2) NEMA 5-15R Group1	
9SX1500	(2) NEMA 5-15R Group2	
9SX2000	(2) NEMA 5-20R + (1) NEMA L5-20R	
9SX3000	(2) NEMA 5-20R Group1 (2) NEMA 5-20R Group2	
9SX3000HW	NA	
9SX1000G	(3) IEC320 C13 (2) IEC320 C13 Group1 (1) IEC320 C13 Group2	(2) IEC10A 6 feet (IEC320 C13 to IEC320 C14)
9SX1500G	(3) IEC320 C13 (2) IEC320 C13 Group1 (1) IEC320 C13 Group2	
9SX2000G	(4) IEC320 C13 (2) IEC320 C13 Group1 (2) IEC320 C13 Group2	
9SX3000G	(4) IEC320 C13 + (1) IEC320 C16 (2) IEC320 C13 Group1 (2) IEC320 C13 Group2	
9SX3000GL	(4) NEMA L6-30R + (2) NEMA 6-20R (2) NEMA L6-20R Group1 (2) NEMA L6-20R Group2	

Table 8. Environmental and safety

Certifications	IEC/EN 62040-1 IEC/EN 62040-2: Cat. C1 IEC/EN 62040-3 UL1778 5 th edition CSA 22.2
EMC (Emissions)*	CISPR22 Class B FCC part 15 Class B / ICES-003
EMC (Immunity)	IEC 61000-4-2, (ESD): 8 kV Contact Discharge / 15 kV Air Discharge IEC 61000-4-3, (Radiated field): 10 V/m IEC 61000-4-4, (EFT): 4 kV IEC 61000-4-5, (Surges): 2 kV Differential Mode / 4 kV Common Mode IEC 61000-4-6, (Electromagnetic field): 10 V IEC 61000-4-8, (Conducted magnetic field): 30 A/m

* for output cable < 10m.

Agency markings	CE / cULus / NOM (for 120V models)
Operating temperature	0 to 40 °C (32 to 104 °F) in Online mode, with linear derating for altitude Note: thermal protection switches load to Bypass in case of overheating.
Storage temperature	0 to 40 °C (32 to 104 °F) with batteries -25 to 55 °C (-13 to 130 °F) without batteries
Transit temperature	-25 to 55 °C (-13 to 130 °F)
Relative humidity	0 to 96% no condensing
Operating altitude	Up to 3,000 meters (9,843 ft) above sea level, no derating for 35 °C (95 °F) room temperature
Transit altitude	Up to 10,000 meters (32,808 ft) above sea level
Audible noise	< 50 dBA at 1 meter typical

8. Specifications

Table 9. Battery

	Internal batteries	EBM
Tower configuration	700VA: 24Vdc - 2 x 12V. 9Ah 1000VA: 36Vdc - 3 x 12V. 9Ah 1500VA: 48Vdc - 4 x 12V. 9Ah 2000VA: 96Vdc - 8 x 12V. 9Ah 3000VA: 96Vdc - 8 x 12V. 9Ah	9SXEBM36: 36Vdc - 2 x 3 x 12V. 9Ah 9SXEBM48: 48Vdc - 2 x 4 x 12V. 9Ah 9SXEBM96: 96Vdc - 2 x 8 x 12V. 9Ah
Type	Sealed, maintenance-free, valve-regulated, lead-acid, with minimum 3-year float service life at 25 °C (77 °F). Lifetime is reduced above 25°C (77°F)	
Monitoring	Advanced monitoring for earlier failure detection and warning	
EBM battery cable length	400 mm / 15.75 in	

Frequency converter	Operating mode used to convert the AC-power frequency between the UPS input and output (50Hz -> 60Hz or 60Hz -> 50Hz).
Low-battery warning	This is a battery-voltage level indicating that battery power is low and that the user must take action to prevent the imminent break in the supply of power to the load.
Backup time	Time during which the load can be supplied by the UPS operating on battery power.
Load	Devices or equipment connected to the UPS output.
HE mode	Operating mode by which the load is supplied directly by the AC source if it is within the tolerances defined by the user. This mode reduces the consumption of electrical power.
Normal (double conversion) mode	The normal UPS operating mode in which the AC source supplies the UPS which in turn supplies the connected loads (after electronic double conversion).
Normal AC source	Normal source of power for the UPS.
Relay contacts	Contacts supplying information to the user in the form of signals.
UPS	Uninterruptible Power Supply.

