

## Are you emergency power ready?

The Powertron® Tap Box makes your facility “emergency power ready,” avoiding the clumsy, costly and time consuming process of connecting temporary power. The installation of a Powertron® Tap Box allows you to:



- Establish a quick connection during power outages and load banking
- Predetermine load requirements, generator sizing and cable lengths
- Identify proper location for the temporary generator; minimizing disruption
- Improve safety and security by eliminating exposed cables and clutter

**NEMA 3R  
OUTDOOR RATED**



### Technical Data

Rating	3200 Amps, 3 Phase, 4 Pole, 5 Wire, 208Y/120 VAC, 240/120 VAC, 480Y/277 VAC, or 600/347 VAC
Enclosure	Pad mount, mild steel or stainless steel, weather tight enclosure
Dimensions	74"H x 48"W x 48"D
Incoming Utility Power Connection	Tin plated copper bus bar
Completed Assembly Safety Agency Approved	cULus Listed 1008   Control # 47HY   Product ID: Enclosed Power Inlet cULus Listed 1773   Control # XCKT   Product ID: Enclosed Power Outlet

### Key Features and Benefits

Security and Safety	Powertron's® Trapped Cable Door provides added security and safety while the generator cables are connected to the tap box. Additional features such as the KIRK® Key field assembled kit and lockable door also provides greater security and safety.
Cold Weather Startup	Receptacle allows power to be provided safely to a generator block heater and battery charger for cold weather operation.
Automatic Startup	During inclement weather conditions or during a load bank test, the Start/Stop terminals enable your mobile generator to standby to automatically restore power to your facility when using an Automatic Transfer Switch.
Backup Power Contingency Plan	Provides your business the ability to have an emergency back power contingency plan into your facility.
Harsh Weather Protection	Engineered and tested to withstand the toughest conditions. Features of the enclosure such as the trapped cable door adds protection during inclement weather conditions.
Uncompromising Quality	Engineered and assembled with the highest quality components from the most respected and leading manufacturers in their industry.

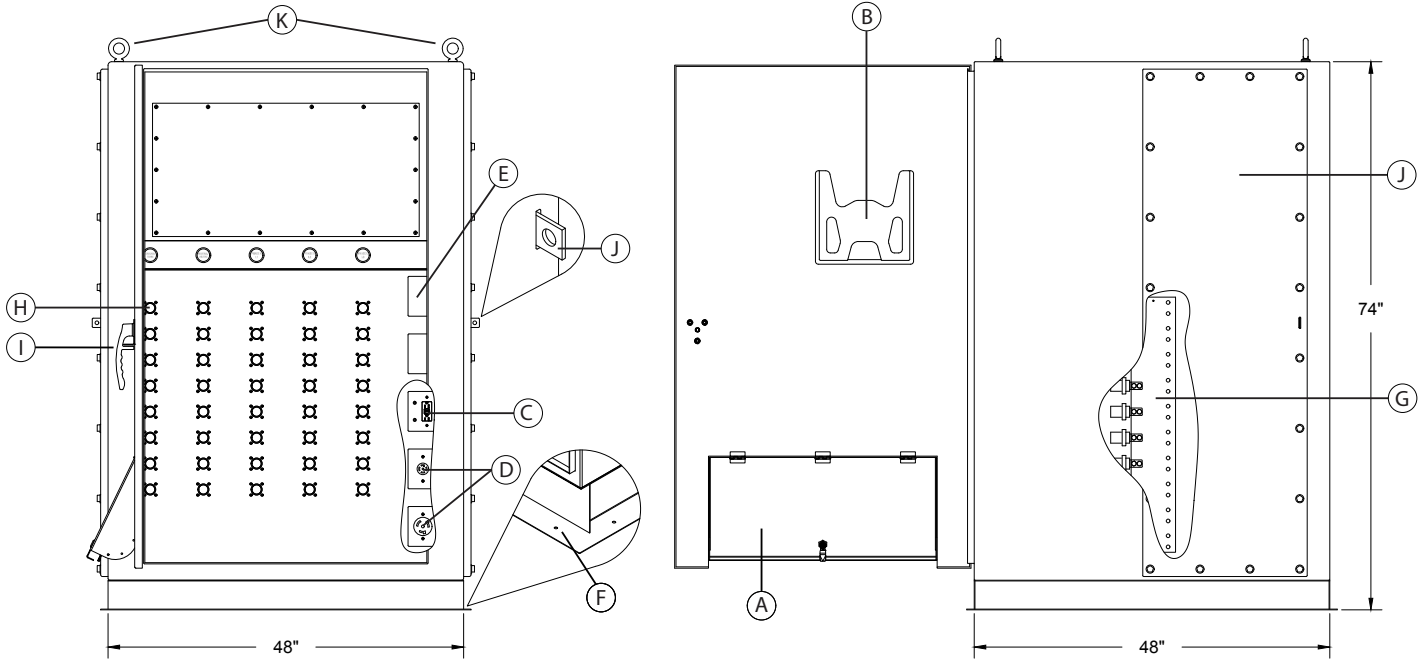

Enclosure Specifications							
Type	Height	Width	Depth	Material	Color/Finish	Unit Weight	Shipping Weight
NEMA 3R	74.0"	48.0"	48.0"	Mild Steel	Powder Coat Light Ivory	1,100 lbs.	1,200 lbs.
				Stainless Steel			

KIRK® KEY TRAPPED DOOR LOCK			FIELD ASSEMBLED KIT (Not Included)
Part Number	Description	Kit Includes	
TBQC-KIRKF9831-001	Single Barrel Opening	Mounting Bracket, Hardware & Instructions	
TBQC-KIRKF9831-002	Double Barrel Opening	Mounting Bracket, Hardware & Instructions	

PHASE ROTATION MONITOR			FIELD ASSEMBLED KIT (Not Included)
Part Number	Description	Kit Includes	
TBCQ-MONITOR-KT2	For 240V to 600V Tap Boxes Only <i>(208V not available)</i>	Relay Module, Cable Leads & Instructions	

CABLE CONNECTORS			FIELD ASSEMBLED KIT (Not Included)
Lug Type	Available Cable Sizes	Kit Includes	
Mechanical Lug	6 STR to 600 Kcmil	(5) Lugs & Hardware	
Compression Lug	250 Kcmil to 600 Kcmil	(5) Lugs & Hardware	

**Standard Components**

A	Trapped Cable Door
B	Owner's Manual Holder
C	Remote Start/Stop Terminals & GFCI 20 Amp Receptacle
D	30A & 50A Twist-Lock Receptacle
E	Cover Plate Shall Only Be Removed When Installing Powertron® Phase Rotation Monitor
F	Stainless Steel Pad Mount: Approx. Pad Dimensions (50"W x 50"D)
G	(5X) Copper Bus Bar, Tin Plated, Mounting Holes 0.50" Dia. <i>(See Mechanical Lug Kit for Building Wire Connection Options)</i>
H	Series 16, 400 Amp, 600 VAC, Single Pole Cam-Lock Receptacle
I	Key Lock Handle
J	(2X) Utility Side Door Secured with Penta Bolts & (2X) Pad Lock Provisions <i>(Penta Socket Included &amp; Pad Locks not Included)</i>
K	Eye Lifting Hooks

**Ordering Information** Example TBQCSM32-LPMS480

<b>TBQCS</b>		<b>32</b>	-		
SERIES	CAM-LOCK TYPE	AMPERAGE		ENCLOSURE TYPE	VOLTAGE
TBQCS STANDARD	M Male F Female	32 3200 Amp		LPMS LARGE PAD MOUNT MILD STEEL LPSS LARGE PAD MOUNT STAINLESS STEEL	208 208Y/120V 240 240/120V 480 480Y/277V 600 600Y/347V

Voltage	Ground	Neutral	L1	L2	L3	# of Rows
208Y/120	GRN	WHT	BLK	RED	BLU	x8 Rows
240/120	GRN	WHT	BLK	RED	BLU	x8 Rows
480Y/277	GRN	WHT	BRN	ORG	YEL	x8 Rows
600/347	GRN	WHT	BLK	RED	BLU	x8 Rows

POWERTRON® Tap Box Warranty and Terms and Conditions of Sale are available upon request or at [www.powertronsolutions.com](http://www.powertronsolutions.com)