

OPERATION MANUAL



WHISPERWATT™ SERIES
MODEL
DCA36SPXU4F
60 Hz GENERATOR
(ISUZU 4LE2X DIESEL ENGINE)

INSTRUCTION MANUAL NO. M1844300324C

Revision #7 (01/09/24)

To find the latest revision of this publication or associated parts manual, visit our website at:

www.mqpower.com



THIS MANUAL MUST ACCOMPANY THE EQUIPMENT AT ALL TIMES.

PROPOSITION 65 WARNING



TABLE OF CONTENTS

DCA36SPXU4F 60 Hz Generator

- Proposition 65 Warning 2
- Table of Contents..... 3
- Safety Decals 4
- Safety Information 5–10
- Specifications 11
- Dimensions..... 12
- Installation 14–15
- General Information..... 16
- Major Components 17
- Engine/Generator Control Panel 18–19
- Output Terminal Panel Familiarization..... 20–22
- Load Application 23
- Gauge Reading 24
- Output Terminal Panel Connections 25
- Inspection/Setup..... 26–29
- Generator Start-Up Procedure
(Manual Mode) 30–32
- Generator Start-Up Procedure
(Auto Mode)..... 33
- Generator Shutdown Procedures 34
- Maintenance 35–41
- Troubleshooting (Diagnostics)..... 42
- Troubleshooting (Generator) 43
- Troubleshooting (Engine) 44–45
- Generator Wiring Diagram (M184000503A)..... 46
- Engine Wiring Diagram (M1814100533) 47
- Controller Wiring Diagram (M1814101603C) 48
- Battery Charger Wiring Diagram (Option) 49
- Engine Block Heater Wiring Diagram (Option) 50

NOTICE
Specifications are subject to change without notice.

SAFETY INFORMATION

Do not operate or service the generator before reading the entire manual. Safety precautions should be followed at all times when operating this generator. Failure to read and understand the safety messages and operating instructions could result in injury to yourself and others.

SAFETY MESSAGES

The four safety messages shown below will inform you about potential hazards that could injure you or others. The safety messages specifically address the level of exposure to the operator and are preceded by one of four words: **DANGER**, **WARNING**, **CAUTION** or **NOTICE**.

SAFETY SYMBOLS

 **DANGER**

Indicates a hazardous situation which, if not avoided, **WILL** result in **DEATH** or **SERIOUS INJURY**.

 **WARNING**

Indicates a hazardous situation which, if not avoided, **COULD** result in **DEATH** or **SERIOUS INJURY**.







 **CAUTION**

Indicates a hazardous situation which, if not avoided, **COULD** result in **MINOR** or **MODERATE INJURY**.

NOTICE

Addresses practices not related to personal injury.

Potential hazards associated with the operation of this generator will be referenced with hazard symbols which may appear throughout this manual in conjunction with safety messages.

Symbol	Safety Hazard
	Lethal exhaust gas hazards
	Explosive fuel hazards
	Burn hazards
	Overspeed hazards
	Rotating parts hazards
	Pressurized fluid hazards
	Electric shock hazards

SAFETY INFORMATION

GENERAL SAFETY

CAUTION

- **NEVER** operate this generator without proper protective clothing, shatterproof glasses, respiratory protection, hearing protection, steel-toed boots and other protective devices required by the job or city and state regulations.





- **NEVER** operate this generator when not feeling well due to fatigue or illness, or when on medication. 
- **NEVER** operate this generator under the influence of drugs or alcohol.



- **ALWAYS** check the generator for loosened threads or bolts before starting.
- **NEVER** use the generator for any purpose other than its intended purposes or applications.

NOTICE

- This generator should only be operated by trained and qualified personnel 18 years of age and older.
- Whenever necessary, replace nameplate, operation and safety decals when they become difficult to read.
- Manufacturer does not assume responsibility for any accident due to equipment modifications. Unauthorized modification of the generator will void all warranties.
- **NEVER** use accessories or attachments that are not recommended by MQ Power for this generator. Damage to the generator and/or injury to the user may result.
- **ALWAYS** know the location of the nearest **fire extinguisher**. 
- **ALWAYS** know the location of the nearest **first aid kit**. 

- **ALWAYS** know the location of the nearest phone or **keep a phone on the job site**. Also, know the phone numbers of the nearest **ambulance, doctor, and fire department**. This information will be invaluable in the case of an emergency.



GENERATOR SAFETY

DANGER

- **NEVER** operate the generator in an explosive atmosphere or near combustible materials. An explosion or fire could result causing **severe bodily harm or even death**. 

WARNING

- **NEVER** disconnect any **emergency or safety devices**. These devices are intended for operator safety. Disconnection of these devices can cause **severe injury, bodily harm or even death**. Disconnection of any of these devices will void all warranties.

CAUTION

- **NEVER** lubricate components or attempt service on a **running generator**.

NOTICE

- **ALWAYS** ensure the generator is on level ground before use.
- **ALWAYS** keep the generator in proper running condition.
- Fix damage to the generator and replace any broken parts immediately.
- **ALWAYS** store the generator properly when it is not being used. The generator should be stored in a clean, dry location out of the reach of children and unauthorized personnel.

SAFETY INFORMATION

ENGINE SAFETY

DANGER

- The engine fuel exhaust gases contain poisonous carbon monoxide. This gas is colorless and odorless, and can cause **death** if inhaled.
- The engine of this generator requires an adequate, free flow of cooling air. **NEVER** operate this equipment in any enclosed or narrow area where free flow of the air is restricted. If the air flow is restricted it will cause injury to people and property and serious damage to the equipment or engine.



- When operating the generator outdoors, **DO NOT** place the generator near doors, windows or vents that could allow carbon monoxide to enter and build up in occupied spaces.

WARNING

- **NEVER** place hands or fingers inside the engine compartment when the engine is running.
- **NEVER** operate the engine with heat shields or guards removed.
- Keep fingers, hands, hair and clothing away from all moving parts to prevent injury.
- **NEVER** operate the generator with the doors open. Stop the engine before servicing.
- **DO NOT** remove the radiator cap while the engine is hot. High pressure boiling water will gush out of the radiator and severely scald any persons in the general area of the generator.
- **DO NOT** remove the coolant drain plug while the engine is hot. Hot coolant will gush out of the coolant tank and severely scald any persons in the general area of the generator.
- **DO NOT** drain the engine oil while the engine is hot. Hot oil will gush out and severely scald any persons near the generator.



- Operation of the generator may create sparks that can start fires around dry vegetation. A spark arrestor may be required. The operator should contact local fire agencies for laws or regulations relating to fire prevention requirements.

CAUTION

- **NEVER** touch the hot exhaust manifold, muffler or cylinder. Allow these parts to cool before servicing the generator.



NOTICE

- **NEVER** run the engine without an air filter or with a dirty air filter. Severe engine damage may occur. Service the air filter frequently to prevent engine malfunction.
- **NEVER** tamper with the factory settings of the engine or engine governor. Damage to the engine or generator can result if operating in speed ranges above the maximum allowable.



- Wet stacking is a common problem with diesel engines which are operated for extended periods with light or no load applied. When a diesel engine operates without sufficient load (less than 30-35% of the rated output), it will not operate at its optimum temperature. This will allow unburned fuel to accumulate in the exhaust system, which can foul the fuel injectors, engine valves and exhaust system, including turbochargers, and reduce the operating performance.

In order for a diesel engine to operate at peak efficiency, it must be able to provide fuel and air in the proper ratio and at a high enough engine temperature for the engine to completely burn all of the fuel.

Wet stacking does not usually cause any permanent damage and can be alleviated if additional load is applied to relieve the condition. It can reduce the system performance and increase maintenance. Applying an increasing load over a period of time until the excess fuel is burned off and the system capacity is reached usually can repair the condition. This can take several hours to burn off the accumulated unburned fuel.

SAFETY INFORMATION

FUEL SAFETY

DANGER

- **NEVER** start the engine near spilled fuel or combustible fluids. Diesel fuel is extremely flammable and its vapors can cause an explosion if ignited.
- **ALWAYS** refuel in a well-ventilated area, away from sparks and open flames.
- **ALWAYS** use extreme caution when working with **flammable** liquids.
- **NEVER** fill the fuel tank while the engine is **running** or **hot**.
- **NEVER** overfill the fuel tank. Spilled fuel can ignite if it comes into contact with hot engine parts or sparks from the ignition system.
- Store fuel in appropriate containers, in well-ventilated areas and away from sparks and flames.
- **NEVER** use fuel as a cleaning agent.
- **NEVER** smoke around or near the equipment. Fire or explosion could result from fuel vapors or if fuel is spilled on a hot engine.



TOWING SAFETY

CAUTION

- Check with your local county or state safety towing regulations, in addition to meeting **Department of Transportation (DOT) Safety Towing Regulations**, before towing your generator.
- Refer to the MQ Power trailer manual for additional safety information.
- In order to reduce the possibility of an accident while transporting the generator on public roads, **ALWAYS** make sure that the trailer that supports the generator and the towing vehicle are both mechanically sound and in good operating condition.
- **ALWAYS** shut down the engine before transporting.



- Make sure the hitch and coupling of the towing vehicle are rated equal to or greater than the trailer **gross vehicle weight rating**.
- **ALWAYS** inspect the hitch and coupling for wear. **NEVER** tow a trailer with defective hitches, couplings, chains, etc.
- Check the tire air pressure on both the towing vehicle and the trailer. **Inflate trailer tires as indicated on side wall of tire**. Also check the tire tread wear on both vehicles.
- **ALWAYS** make sure the trailer is equipped with **safety chains**.
- **ALWAYS** properly attach the trailer's safety chains to the towing vehicle.
- **ALWAYS** make sure the vehicle and trailer directional, backup, brake, and trailer lights are connected and working properly.
- DOT requirements include the following:
 - Connect and test electric brake operation.
 - Secure portable power cables in cable tray with tie wraps.
- The maximum speed for highway towing is **55 MPH** unless posted otherwise. Recommended off-road towing is not to exceed **15 MPH** or less depending on the type of terrain.
- Avoid sudden stops and starts. These can cause skidding or jackknifing. Smooth, gradual starts and stops will improve towing.
- Avoid sharp turns to prevent rolling.
- The trailer should be adjusted to a level position at all times when towing.
- Raise and lock the trailer wheel stand in the upright position when towing.
- Place **chock blocks** underneath the wheels to prevent **rolling** while parked.
- Place **support blocks** underneath the trailer's bumper to prevent **tipping** while parked.
- Use the trailer's swivel jack to adjust the trailer height to a level position while parked.

SAFETY INFORMATION

ELECTRICAL SAFETY

DANGER

- **NEVER** touch the output terminals during operation. Contact with the output terminals during operation can cause **electrocution, electrical shock, or burn**.



- The electrical voltage required to operate the generator can cause **severe injury or even death** through physical contact with live circuits. Turn the generator and all circuit breakers **OFF** before performing maintenance on the generator or making contact with the output terminals.

- **NEVER** insert any objects into the output receptacles during operation. This is extremely dangerous. The possibility exists of **electrical shock, electrocution or death**.



- Backfeed to a utility system can cause **electrocution** and/or property damage. **NEVER** connect the generator to a building's electrical system without a transfer switch or other approved device. All installations should be performed by a **licensed electrician** in accordance with all applicable laws and electrical codes. Failure to do so could result in electrical shock or burn, causing **serious injury or even death**.



Power Cord/Cable Safety

DANGER

- **NEVER** let power cords or cables **lay in water**.
- **NEVER** **stand in water** while AC power from the generator is being transferred to a load.
- **NEVER** use **damaged** or **worn** cables or cords when connecting equipment to the generator. Inspect the insulation for cuts.
- **NEVER** grab or touch a live power cord or cable with wet hands. The possibility exists of **electrical shock, electrocution or death**.

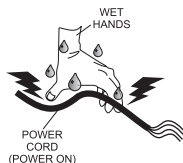

- Make sure power cables are securely connected to the generator's output receptacles. Incorrect connections may cause electrical shock and damage to the generator.

NOTICE

- **ALWAYS** make certain that the proper power or extension cord has been selected for the job. See the Cable Selection Chart in this manual.

Grounding Safety

DANGER

- **ALWAYS** make sure that electrical circuits are properly grounded to a suitable earth ground (ground rod) per the National Electrical Code (NEC) and local codes before operating the generator. **Severe injury or death by electrocution** can result from operating an ungrounded generator.
- **NEVER** use gas piping as an electrical ground.

BATTERY SAFETY

DANGER

- **DO NOT** drop the battery. There is a possibility that the battery will explode.
- **NEVER** expose the battery to open flames, sparks, cigarettes, etc. The battery contains combustible gases and liquids. If these gases and liquids come into contact with a flame or spark, an explosion could occur.



WARNING

- **ALWAYS** wear safety glasses when handling the battery to avoid eye irritation. The battery contains acids that can cause injury to the eyes and skin.
- Use well-insulated gloves when picking up the battery.
- **ALWAYS** keep the battery charged. If the battery is not charged, combustible gas will build up.
- **ALWAYS** recharge the battery in a well-ventilated environment to avoid the risk of a dangerous concentration of combustible gases.
- If the battery liquid (dilute sulfuric acid) comes into contact with **clothing or skin**, rinse skin or clothing immediately with plenty of water.



SAFETY INFORMATION

- If the battery liquid (dilute sulfuric acid) comes into contact with **eyes**, rinse eyes immediately with plenty of water and contact the nearest doctor or hospital to seek medical attention.

CAUTION

- **ALWAYS** disconnect the **NEGATIVE** battery terminal before performing service on the generator.
- **ALWAYS** keep battery cables in good working condition. Repair or replace all worn cables.

ENVIRONMENTAL SAFETY/DECOMMISSIONING

NOTICE

Decommissioning is a controlled process used to safely retire a piece of equipment that is no longer serviceable. If the equipment poses an unacceptable and unreparable safety risk due to wear or damage or is no longer cost effective to maintain (beyond life-cycle reliability) and is to be decommissioned (demolition and dismantlement), be sure to follow the rules below:

- **NEVER** pour waste or oil directly onto the ground, down a drain, or into any water source.
- Contact your country's Department of Public Works or recycling agency in your area and arrange for proper disposal of any electrical components, waste or oil associated with this equipment.
- When the life cycle of this equipment is over, remove the battery and bring it to an appropriate facility for lead reclamation. Use safety precautions when handling batteries that contain sulfuric acid.
- When the life cycle of this equipment is over, it is recommended that the frame and all other metal parts be sent to a recycling center.



Metal recycling involves the collection of metal from discarded products and its transformation into raw materials to use in manufacturing a new product.

Recyclers and manufacturers alike promote the process of recycling metal. Using a metal recycling center promotes energy cost savings.

EMISSIONS INFORMATION

NOTICE

The diesel engine used in this equipment has been designed to reduce harmful levels of carbon monoxide (CO), hydrocarbons (HC), and nitrogen oxides (NOx) contained in diesel exhaust emissions.

This engine has been certified to meet US EPA evaporative emissions requirements in the installed configuration.

Attempting to modify or make adjustments to the engine emission system by unauthorized personnel without proper training could damage the equipment or create an unsafe condition.

Additionally, modifying the fuel system may adversely affect evaporative emissions, resulting in fines or other penalties.

Emission Control Label

The emission control label is an integral part of the emission system and is strictly controlled by regulations.

The label must remain with the engine for its entire life.

If a replacement emission label is needed, please contact your authorized engine distributor.

SPECIFICATIONS

Table 1. Generator Specifications

Model	DCA36SPXU4F
Type	Revolving field, self-ventilated, drip-proof, single bearing
Armature Connection	Series
Phase	1Ø
Standby Output	40 kW (40 kVA)
Prime Output	36 kW (36 kVA)
1Ø Voltage (L-L/L-N) Voltage Selector Switch at 1Ø 240/120	120/240
Power Factor	1.0
Frequency	60 Hz
Speed	1,800 rpm
Aux. AC Power	Single Phase, 60 Hz
Subtransient	0.063
Transient	0.162
Synchronous	1.60
Zero Sequence Reactance	0.0588
Aux. Voltage/Output	4.8 kW (2.4 kW × 2)
Dry Weight	2,448 lb. (1,110 kg)
Wet Weight	3,087 lb. (1,400 kg)

Table 2. Engine Specifications

Model	Isuzu/4LE2X EPA Tier 4 Final Certified	
Type	4-Cycle, water-cooled, direct injection, turbocharged, charge air cooled, EGR and DOC	
No. of Cylinders	4 cylinders	
Bore × Stroke	3.35 in. × 3.78 in. (85 mm × 96 mm)	
Displacement	133 cu. in. (2.179 liter)	
Rated Output	59.0 HP at 1,800 rpm	
Starting	Electric	
Coolant Capacity	4.4 gal. (16.8 liters) ¹	
Lube Oil Capacity	3.2 gal. (12.2 liters) ²	
Lube Oil Type	API service class CJ-4 SAE or JASO DH-2	
Fuel Type	#2 Diesel Fuel (Ultra low sulfur diesel fuel only)	
Fuel Leak Warning Capacity	21.1 gal. (80 liters)	
Fuel Tank Capacity	79.2 gal. (300 liters)	
Fuel Consumption	2.93 gal. (11.1 L)/hr. at full load	2.20 gal. (8.31 L)/hr. at 3/4 load
	1.60 gal. (6.04 L)/hr. at 1/2 load	1.04 gal. (3.92 L)/hr. at 1/4 load
Exhaust Gas After-Treatment System	DOC	
Battery	12V 72Ah × 1	

¹ Includes engine and radiator hoses

² Includes filters

DIMENSIONS

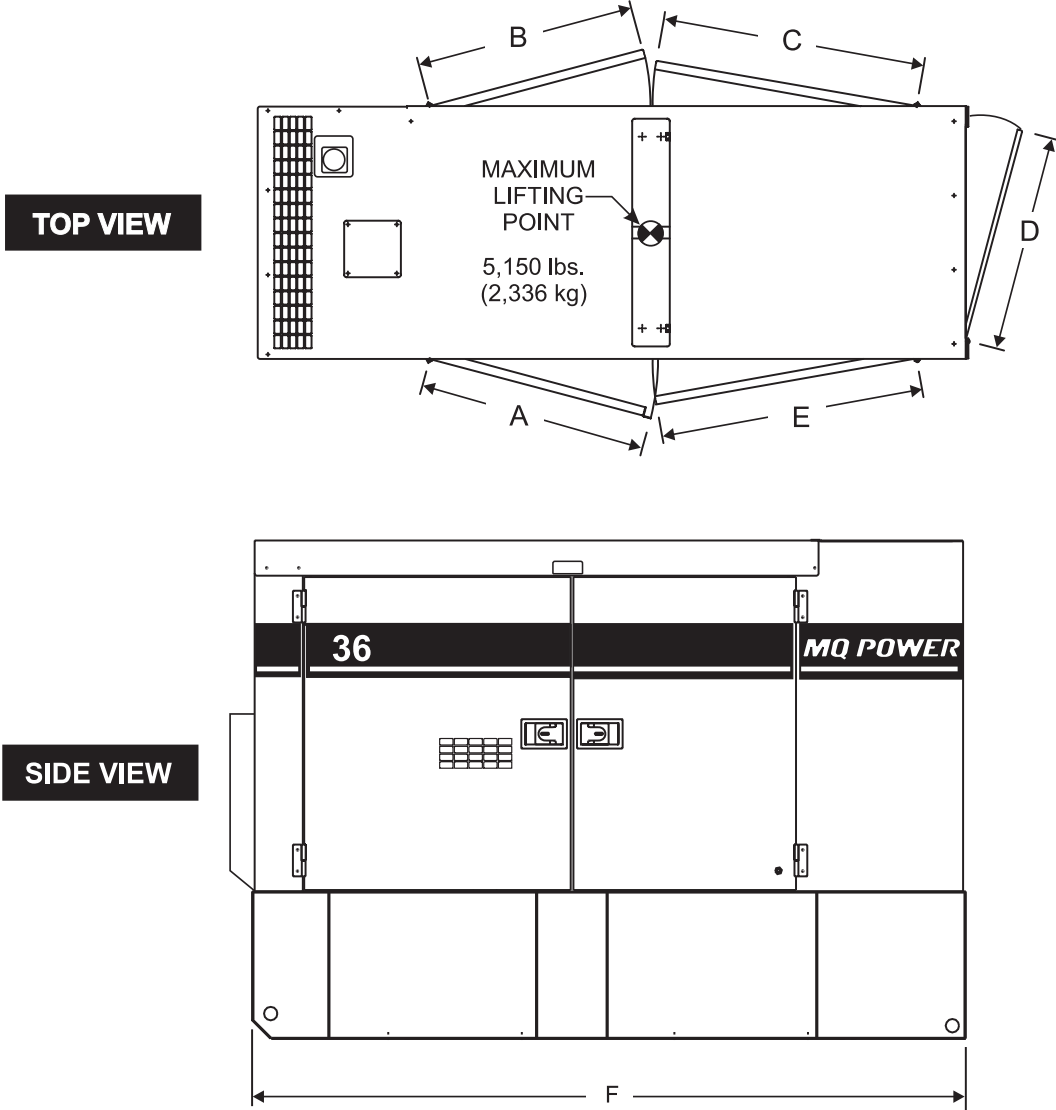

Figure 2. Dimensions

Table 3. Dimensions			
Reference Letter	Dimension in. (mm)	Reference Letter	Dimension in. (mm)
A	28.35 (720)	E	26.18 (665)
B	28.35 (720)	F	87.00 (2,210)
C	26.18 (665)	G	61.00 (1,550)
D	32.28 (820)	H	37.40 (950)

GENERATOR GROUNDING

ALWAYS refer to Article 250 (Grounding and Bonding) of the National Electrical Code (NEC).

NOTICE
ALWAYS check with state, province, district, and municipalities for electrical grounding requirements before using the generator.

Connecting The Ground

Consult with local electrical and safety codes for proper connection based on condition of use. Refer to the Conductor Grounding Table, Article 250 of the NEC handbook.

EXAMPLE of how to ground the unit (Figure 3) if the condition of use requires such a device:

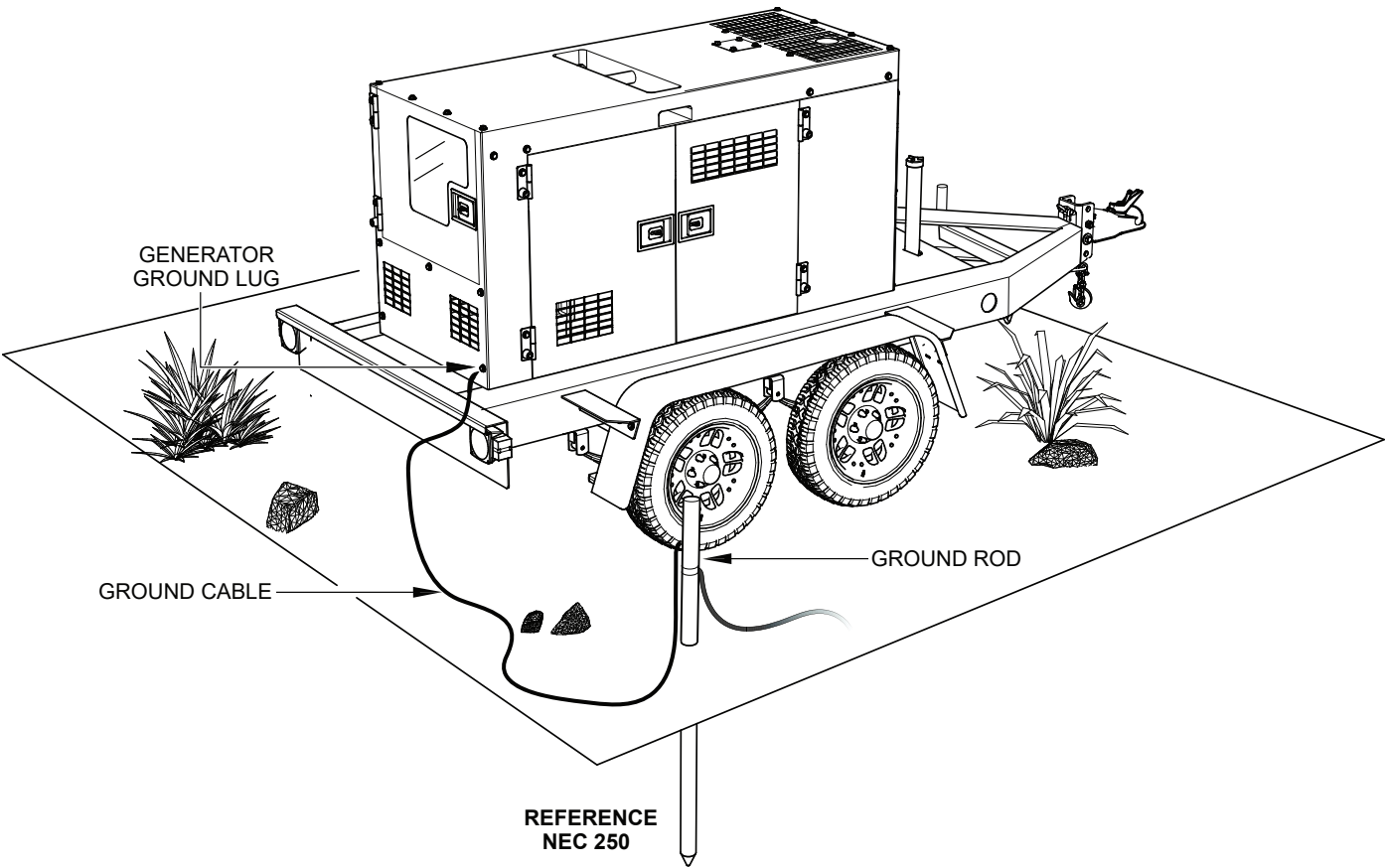

Figure 3. Typical Generator Grounding Application

NOTICE
Trailer-mounted generators are the sole responsibility of MQ Power.

OUTDOOR INSTALLATION

Install the generator in an area that is free of debris, bystanders, and overhead obstructions. Make sure the generator is on secure, level ground so that it cannot slide or shift around. Also, install the generator in a manner so that the exhaust will not be discharged in the direction of nearby homes.

The installation site must be relatively free from moisture and dust. All electrical equipment should be protected from excessive moisture. Failure to do so will result in deterioration of the insulation and will result in short circuits and grounding.

Foreign materials such as dust, sand, lint, and abrasive materials have a tendency to cause excessive wear to engine and alternator parts.

CAUTION

Pay close attention to ventilation when operating the generator inside tunnels and caves. The engine exhaust contains noxious elements. Engine exhaust must be routed to a ventilated area.

INDOOR INSTALLATION

Exhaust gases from diesel engines are extremely poisonous. Whenever an engine is installed indoors the exhaust fumes must be vented to the outside. The engine should be installed at least two feet from any outside wall. Using an exhaust pipe which is too long or too small can cause excessive back pressure which will cause the engine to heat excessively and possibly burn the valves.

MOUNTING

The generator must be mounted on a solid foundation (such as concrete) and set firmly on the foundation to isolate vibration of the generator when it is running. The generator must be mounted at least 6 inches above the floor or grade level as referenced in the National Fire Protection Association handbook (NFPA 110, Chapter 7, Section 7.4).

DO NOT remove the metal skids on the bottom of the generator. They are to resist damage to the bottom of the generator and to maintain alignment.

GENERAL INFORMATION

GENERATOR

This generator (Figure 4) is designed as a high-quality, portable (requires a trailer for transport) power source for telecom sites, lighting facilities, power tools, submersible pumps and other industrial and construction machinery.

OPERATING PANEL

The “Operating Panel” is provided with the following:

- ECU 755 Controller with Gauge Unit Assembly
 - Oil Pressure Gauge
 - Water Temperature Gauge
 - Charging Voltmeter
 - Fuel Gauge
 - Tachometer
- Panel Light/Panel Light Switch
- Pre-Heat Lamp
- Warning Lamp (Diagnostic)
- Hour Meter
- Engine Speed Switch
- Auto Start/Stop Switch
- Fuel Leak Detected Alarm Lamp

CONTROL PANEL

The “Control Panel” is provided with the following:

- Frequency Meter (Hz)
- AC Ammeter (Amps)
- AC Voltmeter (Volts)
- Ammeter Change-Over Switch
- Voltage Regulator
- 3-Pole, 150-Amp Main Circuit Breaker
- “Control Box” (located behind Control Panel)
 - Automatic Voltage Regulator
 - Current Transformer
 - Overcurrent Relay
 - Starter Relay

OUTPUT TERMINAL PANEL

The “Output Terminal Panel” is provided with the following:

- Three 120/240V output receptacles (CS-6369), 50A
- Three auxiliary circuit breakers, 50A
- Two 120V output receptacles (GFCI), 20A
- Two GFCI circuit breakers, 20A
- Four output terminal lugs (1Ø power)
- Battery Charger (Option)
- Engine Block Heater (Option)
- Low Coolant Switch (Option)

OPEN-DELTA EXCITATION SYSTEM

Each generator is equipped with a state-of-the-art, **open-delta** excitation system. The open-delta system consists of an electrically independent winding wound among stationary windings of the AC output section.

There are four connections of the open delta—A, B, C, and D. During steady state loads, the power from the voltage regulator is supplied from the parallel connections of A to B, A to D, and C to D. These three phases of the voltage input to the voltage regulator are then rectified and are the excitation current for the exciter section.

When a heavy load such as a motor starting or a short circuit occurs, the automatic voltage regulator (AVR) switches the configuration of the open delta to the series connection of B to C. This has the effect of adding the voltages of each phase to provide higher excitation to the exciter section and thus better voltage response during the application of heavy loads.

The connections of the AVR to the AC output windings are for sensing only. No power is required from these windings.

The open-delta design provides virtually unlimited excitation current, offering maximum motor-starting capabilities. The excitation does not have a ‘fixed ceiling’ and responds according to the demands of the required load.

ENGINE

This generator is powered by a 4-cylinder, 4-cycle, water-cooled, direct injection, turbocharged, charge air cooled and EGR Isuzu 4LE2X diesel engine. This engine is designed to meet every performance requirement for the generator. Reference Table 2 for engine specifications. In keeping with MQ Power’s policy of constantly improving its products, the specifications quoted herein are subject to change without prior notice.

ELECTRIC GOVERNOR SYSTEM

The electric governor system controls the RPMs of the engine. When the engine demand increases or decreases, the governor system regulates the frequency variation to $\pm 0.25\%$.

EXTENSION CABLES

When electric power is to be provided to various tools or loads at some distance from the generator, extension cords are normally used. Cables should be sized to allow for distance in length and amperage so that the voltage drop between the generator and point of use (load) is held to a minimum. Use the cable selection chart (Table 6) as a guide for selecting proper extension cable size.

MAJOR COMPONENTS

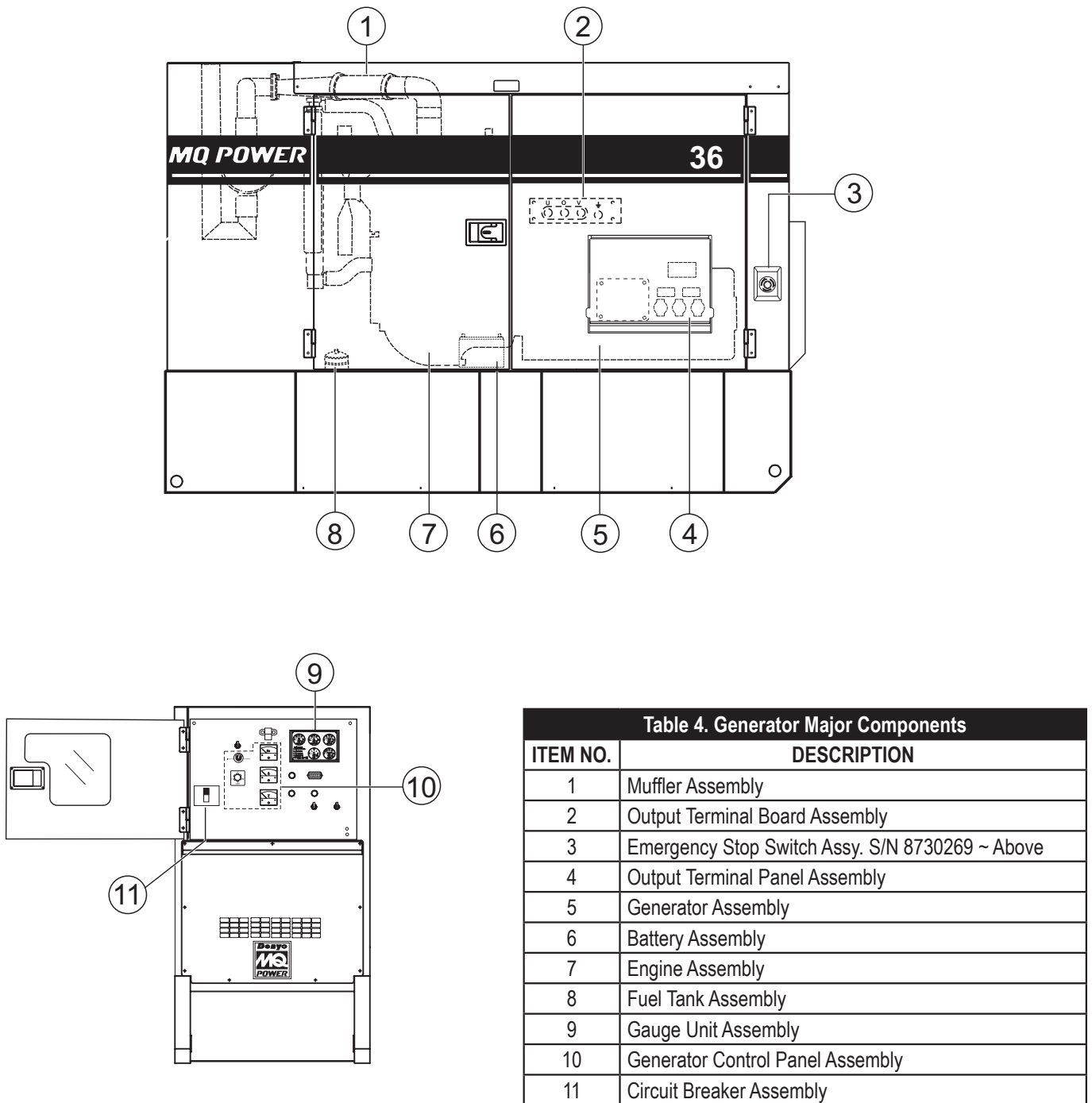

Figure 4. Major Components

ENGINE/GENERATOR CONTROL PANEL

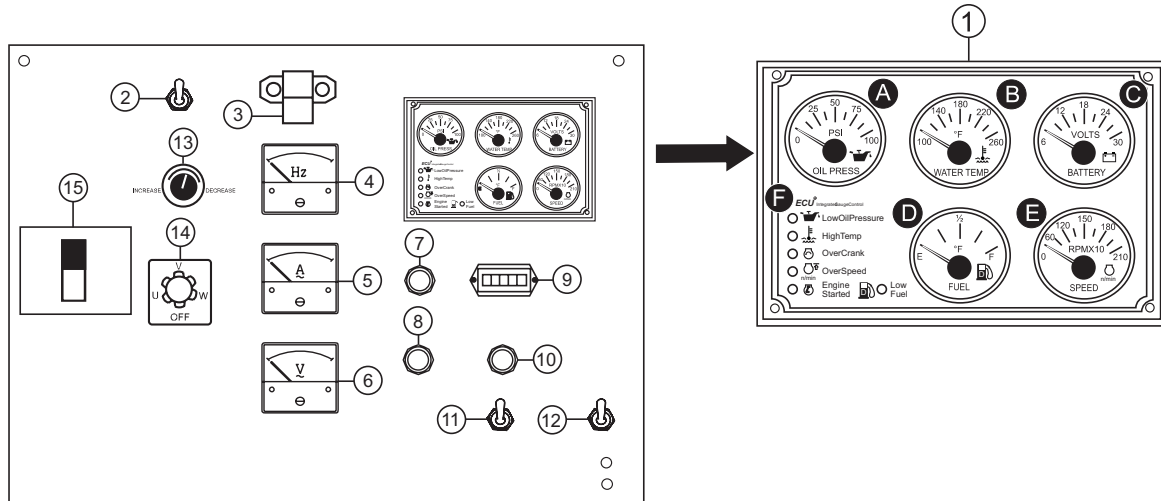

Figure 5. Engine/Generator Control Panel

The definitions below describe the controls and functions of the Engine/Generator Control Panel (Figure 5).

1. **ECU Controller with Gauge Unit Assembly** — This assembly houses the various engine monitoring gauges. These gauges indicate: oil pressure, water temperature, charging voltmeter, fuel, and engine speed RPM (tachometer).

- A. **Oil Pressure Gauge** — During normal operation this gauge should read approximately 50 psi (345 kPa). When starting the generator, the oil pressure may read a little higher, but after the engine warms up the oil pressure should return to the correct pressure range.
- B. **Water Temperature Gauge** — During normal operation this gauge should read approximately 180°F (82°C).
- C. **Charging Voltmeter Gauge** — During normal operation this gauge should indicate minimum 14 VDC.
- D. **Fuel Gauge** — Indicates amount of diesel fuel available.
- E. **Tachometer** — Indicates engine speed in RPM for 60 Hz operation. This meter should indicate 1,800 RPM when the rated load is applied.

F. Warning LEDs

- **Low Oil Pressure LED** — This LED will light when the engine oil pressure drops to 14.2 psi (98 kPa). This condition will cause the engine to shut down.
 - **High Temperature LED** — This LED will light when the coolant temperature has reached 212°F (100°C). This condition will cause the engine to shut down.
 - **Over Crank LED** — This LED will light when the engine has attempted to start 3 times and failed. The interval between the 3 start cycles is approximately 10 seconds.
 - **Over Speed LED** — This LED will light when the engine is running at an unsafe speed. This condition will cause the engine to shut down.
 - **Low Fuel LED** — This LED will light when the fuel level falls below 20%. Shutdown will activate at 5%.
 - **Engine Started LED** — This LED will light when the engine has started and is operating correctly.
2. **Panel Light Switch** — When activated, will turn on control panel light.
3. **Panel Light** — For operation at night, panel light illuminates control panel for ease of reading meters and gauges. Make sure panel light switch is in the **OFF** position when light is not in use.

ENGINE/GENERATOR CONTROL PANEL

4. **Frequency Meter** — Indicates the output frequency in hertz (Hz). Normally 60 Hz.
5. **AC Ammeter** — Indicates the amount of current the load is drawing from the generator per leg selected by the ammeter phase-selector switch.
6. **AC Voltmeter** — Indicates the output voltage present at the **U, O and V Output Terminal Lugs**.
7. **Fuel Leak Detected Alarm Lamp** — When ON, this lamp indicates that fluids in the containment area have reached a high level.
8. **Warning Lamp** — This lamp turns **ON** when an engine fault/failure has occurred. Reference troubleshooting diagnostic section in this manual.
9. **Hour Meter** — Indicates the operational hours of the generator.
10. **Pre-Heat Lamp** — When the Auto Start/Stop Switch is placed in the manual position, this lamp will illuminate to indicate preheating of the engine glow plugs. When the lamp turns off, this indicates that the preheat cycle is complete and the engine can be started.
11. **Auto Start/Stop Switch** — This switch selects either manual or automatic operation. Center position is **OFF** (reset).
12. **Engine Speed Switch** — This switch controls the speed of the engine, low or high.
13. **Voltage Regulator Control** — Allows $\pm 15\%$ manual adjustment of the generator's output voltage.
14. **Ammeter Change-Over Switch** — This switch allows the AC ammeter to indicate the current flowing to the load connected to any phase of the output terminals, or to be switched off. This switch does not affect the generator output in any fashion, it is for current reading only.
15. **Main Circuit Breaker** — This three-pole, 150-amp main breaker is provided to protect the **U, O, and V** output terminal lugs from overload.

OUTPUT TERMINAL PANEL FAMILIARIZATION

OUTPUT TERMINAL PANEL

The Output Terminal Panel (Figure 6) shown below is located on the right-hand side (left from control panel) of the generator. Lift up on the cover to gain access to receptacles and terminal lugs.

NOTICE

Terminal O is neutral bonded to the ground from the factory.

OUTPUT TERMINAL FAMILIARIZATION

The “Output Terminal Panel” (Figure 6) is provided with the following:

- Three 120/240 output receptacles @ 50 amps
- Three Aux. Circuit Breakers @ 50 amps
- Two 120V GFCI receptacles @ 20 amps
- Two GFCI Circuit Breakers @ 20 amps
- Four Output Terminal Lugs (U, O, V, and Ground)

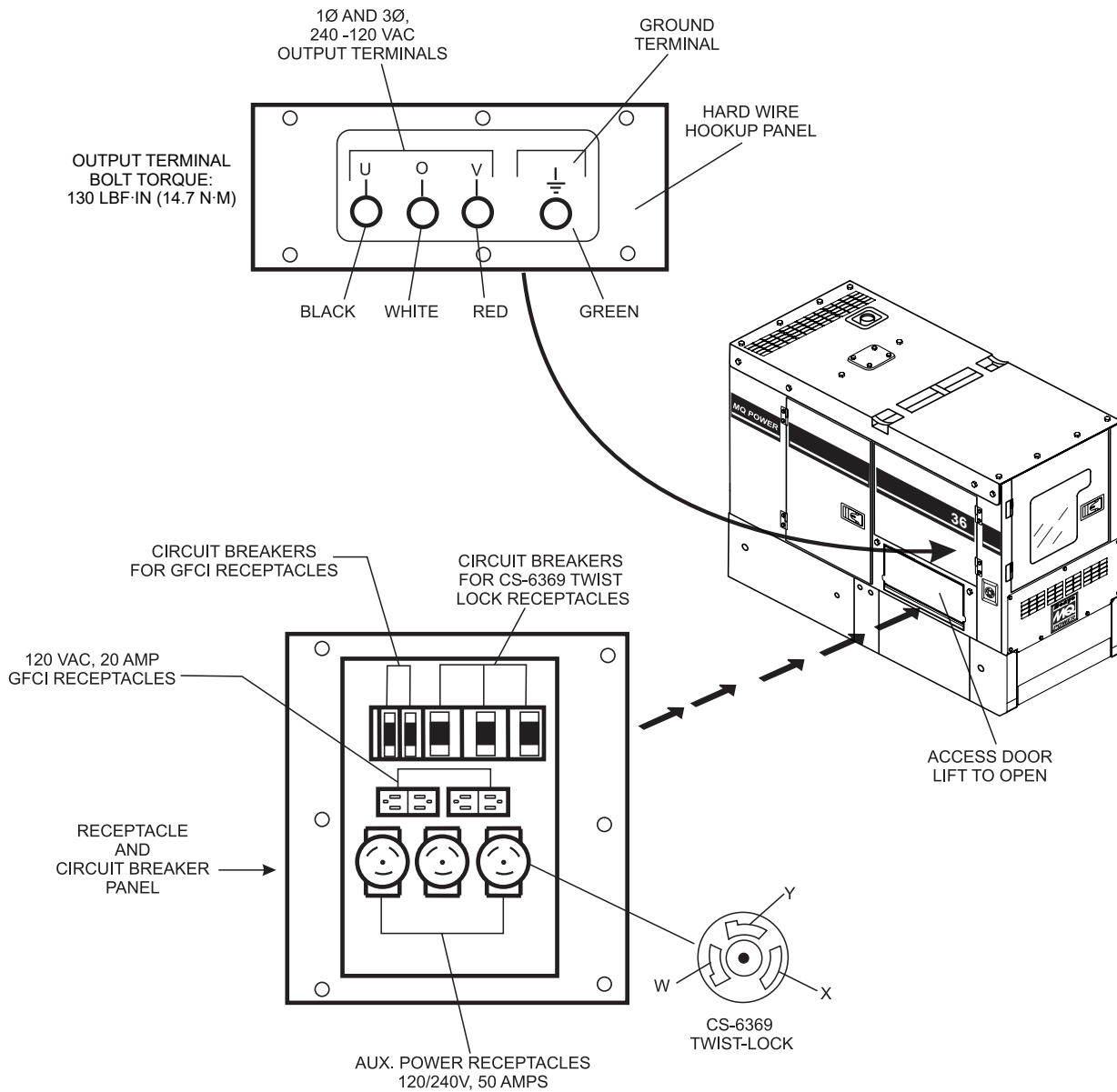

Figure 6. Output Terminal Panel

OUTPUT TERMINAL PANEL FAMILIARIZATION

120 VAC GFCI Receptacles

NOTICE

It is recommended that the GFCI receptacles be tested when the generator is initially uncrated. The receptacles should then be tested daily at startup.

There are two 120 VAC, 20-amp GFCI (duplex NEMA 5-20R) receptacles provided on the output terminal panel. Each receptacle is protected by a 20-amp circuit breaker. These breakers are located directly above the GFCI receptacles. Remember the load output (current) of both GFCI receptacles is dependent on the load requirements of the U, O, and V output terminal lugs.

Pressing the **reset** button resets the GFCI receptacle after being tripped. Pressing the **test button** (Figure 7) in the center of the receptacle will check the GFCI function. Both receptacles should be tested at least once a month. Reference the maintenance section in this manual for further testing of the GFCI receptacle.

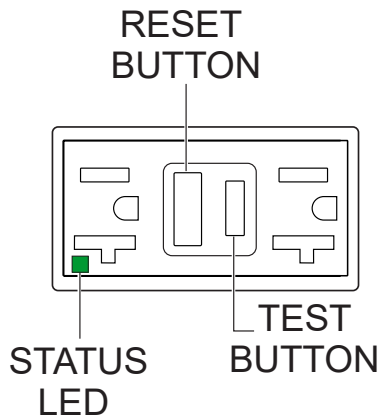

Figure 7. GFCI Receptacle

Twist-Lock Dual-Voltage 120/240 VAC Receptacles

There are two 120/240V, 50-amp auxiliary twist-lock (CS-6369) receptacles (Figure 8) provided on the output terminal panel. These receptacles can **only** be accessed when the main and auxiliary circuit breakers are in the ON position.

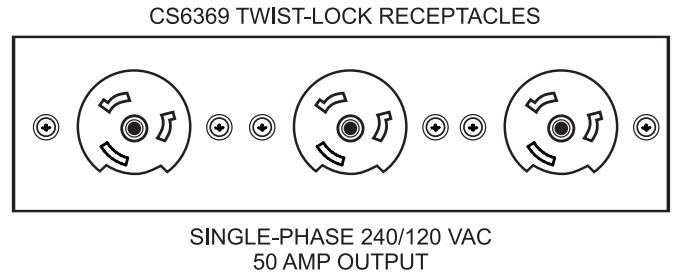

Figure 8. 120/240V Twist-Lock Auxiliary Receptacles

Each auxiliary receptacle is protected by a 50-amp circuit breaker. These breakers are located directly above the GFCI receptacles. Remember the load output (current) on all three receptacles is dependent on the load requirements of the **output terminal lugs**.

Removing The Plastic Face Plate (Hard Wire Hookup Panel)

The **Output Terminal Lugs** are protected by a plastic face plate cover (Figure 9). Unscrew the securing bolts and lift the plastic terminal cover to gain access to the terminal enclosure.

After the load wires have been securely attached to the terminal lugs, reinstall the plastic face plate.

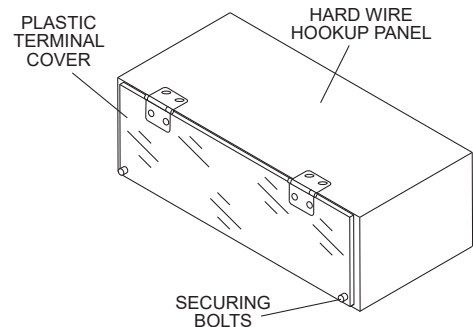

Figure 9. Plastic Face Plate (Output Terminal Lugs)

OUTPUT TERMINAL PANEL FAMILIARIZATION

Connecting Loads

Loads can be connected to the generator by various methods, output terminal lugs, camlocks or the convenience receptacles (Figure 10). Make sure to read the operation manual before attempting to connect a load to the generator.

To protect the output terminals from overload, a 3-pole, 150-amp, **main** circuit breaker is provided. Make sure to switch **ALL** circuit breakers to the **OFF** position prior to starting the engine.

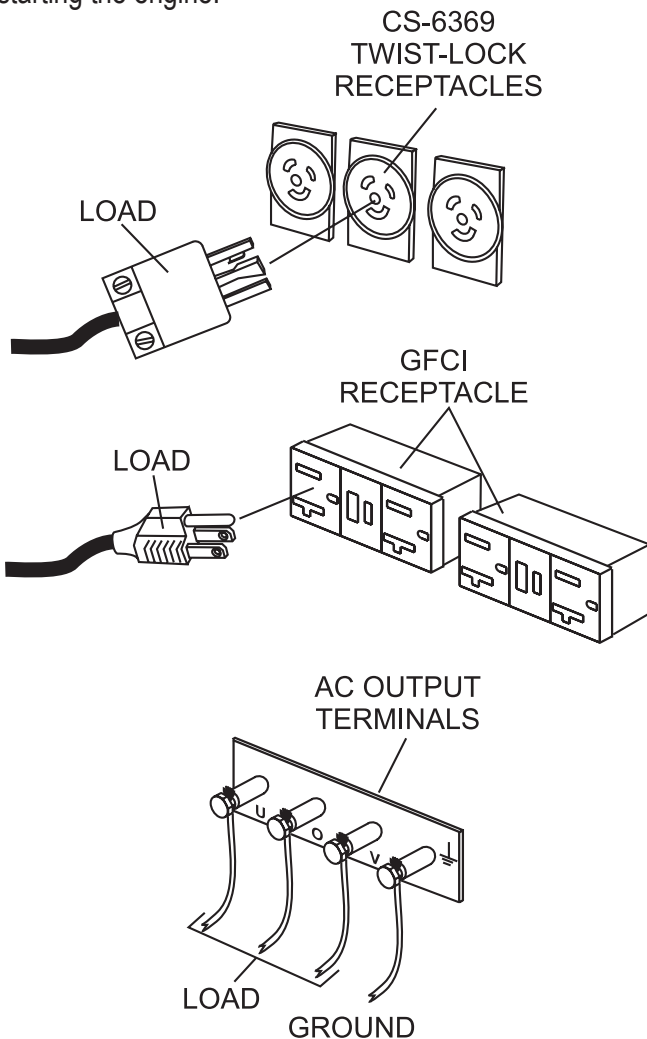

Figure 10. Connecting Loads

Overcurrent Relay

An **overcurrent relay** (Figure 11) is connected to the main circuit breaker. In the event of an overload, both the circuit breaker and the overcurrent relay may trip. If the circuit breaker cannot be reset, the **reset button** on the overcurrent relay must be pressed. The overcurrent relay is located inside the control box.

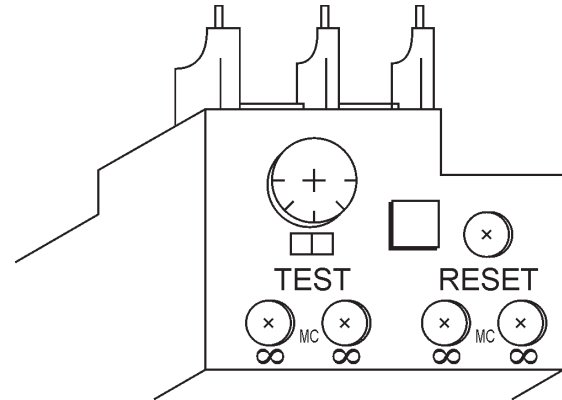

Figure 11. Overcurrent Relay

NOTICE

Remember the **overcurrent relay** monitors the current flowing from the **U, O and V Output Terminal Lugs** to the load.

In the event of a short circuit or overcurrent condition, it will automatically trip the 150-amp main breaker.

To restore power to the **Output Terminal Panel**, press the reset button on the overcurrent relay and place the **main** circuit breaker in the **closed** position (**ON**).

SINGLE-PHASE LOAD

Always be sure to check the nameplate on the generator and equipment to ensure the wattage, amperage, frequency, and voltage requirements are satisfactorily supplied by the generator for operating the equipment.

Generally, the wattage listed on the nameplate of the equipment is its rated output. Equipment may require 130–150% more wattage than the rating on the nameplate, as the wattage is influenced by the efficiency, power factor and starting system of the equipment.

NOTICE

If wattage is not given on the equipment's nameplate, approximate wattage may be determined by multiplying nameplate voltage by the nameplate amperage.

$$\text{WATTS} = \text{VOLTAGE} \times \text{AMPERAGE}$$

The power factor of this generator is 1.0. See Table 5 below when connecting loads.

Table 5. Power Factor By Load

Type of Load	Power Factor
Single-phase induction motors	0.4–0.75
Electric heaters, incandescent lamps	1.0
Fluorescent lamps, mercury lamps	0.4–0.9
Electronic devices, communication equipment	1.0
Common power tools	0.8

Table 6. Cable Selection (60 Hz, Single-Phase Operation)

Current in Amperes	Load in Watts		Maximum Allowable Cable Length			
	At 100 Volts	At 200 Volts	#10 Wire	#12 Wire	#14 Wire	#16 Wire
2.5	300	600	1,000 ft.	600 ft.	375 ft.	250 ft.
5	600	1,200	500 ft.	300 ft.	200 ft.	125 ft.
7.5	900	1,800	350 ft.	200 ft.	125 ft.	100 ft.
10	1,200	2,400	250 ft.	150 ft.	100 ft.	
15	1,800	3,600	150 ft.	100 ft.	65 ft.	
20	2,400	4,800	125 ft.	75 ft.	50 ft.	

CAUTION: Equipment damage can result from low voltage.

NOTICE

Cable selection table is a general guideline. **ALWAYS** consult local and national electrical codes when sizing cables.

NOTICE

Motors and motor-driven equipment draw much greater current for starting than during operation.

An inadequately sized connecting cable which cannot carry the required load can cause a voltage drop which can burn out the appliance or tool and overheat the cable. See Table 6.

- When connecting a resistance load such as an incandescent lamp or electric heater, a capacity of up to the generating set's rated output (kW) can be used.
- When connecting a fluorescent or mercury lamp, a capacity of up to the generating set's rated output (kW) multiplied by 0.6 can be used.
- When connecting an electric drill or other power tools, pay close attention to the required starting current capacity.

When connecting ordinary power tools, a capacity of up to the generating set's rated output (kW) multiplied by 0.8 can be used.

DANGER

Before connecting this generator to any building's electrical system, a **licensed electrician** must install an **isolation (transfer) switch**. Serious damage to the building's electrical system may occur without this transfer switch.

HOW TO READ THE AC AMMETER GAUGE

The AC ammeter gauge is controlled by the AC ammeter change-over switch.

This switch is located on the control panel and **does not** affect the generator output. It is provided to help observe how much power is being supplied, produced at the UOV terminal lugs.

AC Ammeter Gauge Reading

Place the **AC Ammeter Change-Over Switch** (Figure 12) in the U position and observe the current reading (load drain) on the U terminal as indicated on the **AC Ammeter Gauge**. This process can be repeated for terminal V.

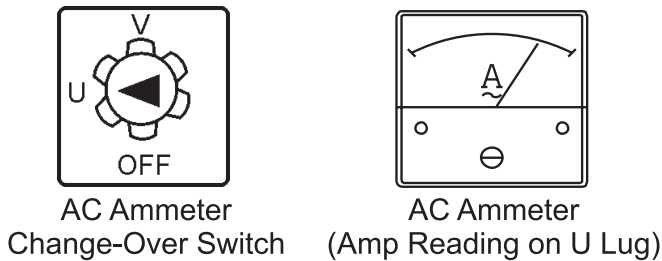

Figure 12. Current Reading (Load Drain)

NOTICE

The **ammeter** gauge will only show a reading when the **Output Terminal Lugs** are connected to a load and is in use.

OUTPUT TERMINAL PANEL CONNECTIONS

UOV TERMINAL OUTPUT VOLTAGES

240/120V output voltages can be obtained using the **output terminal lugs**.

The voltage regulator (Figure 14) allows the user to increase or decrease the selected voltage.

1Ø-240V Output Terminal Voltage

1. Connect the load wires to the output terminal lugs as shown in Figure 13.

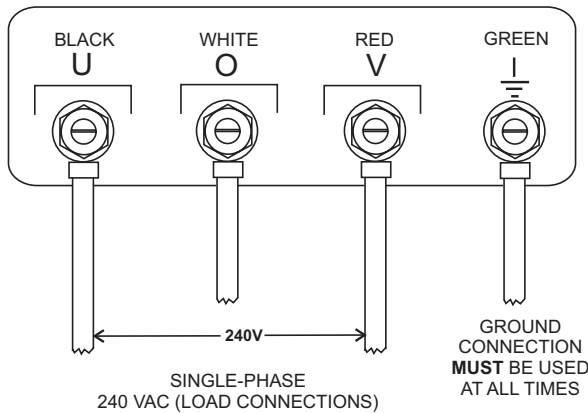

**Figure 13. Output Terminal Lugs
1Ø-240V Connections**

2. Turn the voltage regulator (Figure 14) clockwise to increase voltage output, and turn counterclockwise to decrease voltage output. Use the voltage regulator whenever fine tuning of the output voltage is required.

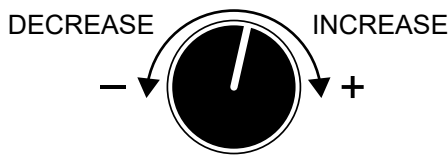
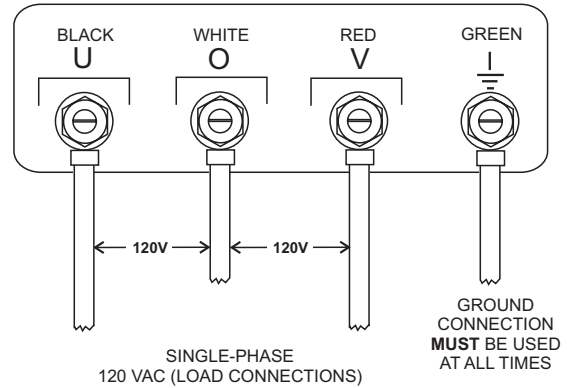

Figure 14. Voltage Regulator

1Ø-120V Output Terminal Voltage

1. Connect the load wires to the output terminal lugs as shown in Figure 15.



**Figure 15. Output Terminal Lugs
1Ø-120V Connections**

NOTICE

ALWAYS make sure that the connections to the UOV terminals are **secure** and **tight**. The possibility of arcing exists, that could cause a fire.

2. Turn the voltage regulator (Figure 14) clockwise to increase voltage output, and turn counterclockwise to decrease voltage output.

ENGINE OIL CHECK

1. To check the engine oil level, place the generator on secure, level ground with the engine stopped.
2. Remove the engine oil dipstick (Figure 16) from its holder and wipe it clean.

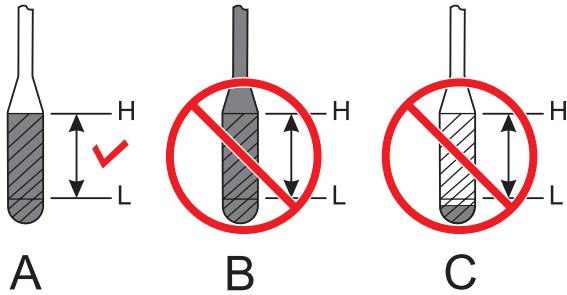

Figure 16. Engine Oil Dipstick

3. Reinsert the dipstick, then remove the dipstick from its holder. Check the oil level shown on the dipstick (Figure 16).
4. Verify that the engine oil level is maintained between the H and L markings on the dipstick as shown in Figure 16A.
5. If the engine oil level is low (Figure 16C), remove the oil filler cap and fill to a safe operating level (max) as indicated by the dipstick (Figure 16A). Fill with recommended type oil as listed in Table 7. Maximum oil capacity is 3.2 gallons (12.2 liters).

NOTICE

When adding engine oil **DO NOT** overfill (Figure 16B).

When checking the engine oil, be sure to check if the oil is clean. If the oil is not clean, drain the oil as referenced in the maintenance section of this manual.

Table 7. Recommended Motor Oil		OIL: SAE	
°F	°C		
122	50	10W/40	30
104	40	10W/40	30
86	30	10W/40	30
68	20	10W/40	30
50	10	10W/40	30
32	0	10W/40	30
-14	-10	ARCTIC OIL	5W/30
-4	-20	ARCTIC OIL	5W/30
-22	-30	ARCTIC OIL	5W/30
-40	-40	ARCTIC OIL	5W/30
		15W/30	10W/30
		10W	20W/40

FUEL CHECK

! DANGER



Fuel spillage on a **hot** engine can cause a **fire** or **explosion**. If fuel spillage occurs, wipe up the spilled fuel completely to prevent fire hazards. **NEVER** smoke around or near the generator.

Refilling The Fuel System

! CAUTION

ONLY properly trained personnel who have read and understand this section should refill the fuel tank system.

This generator has an internal fuel tank (Figure 17) located inside the enclosure and may also be equipped with a trailer-mounted fuel tank. **ALWAYS** fill the fuel tank with clean, fresh **#2 diesel fuel**. **DO NOT** fill the fuel tank beyond its capacity.

Pay attention to the fuel tank capacity when replenishing fuel. The fuel tank cap must be closed tightly after filling. Handle fuel in a safety container. If the container does not have a spout, use a funnel. Wipe up any spilled fuel immediately.

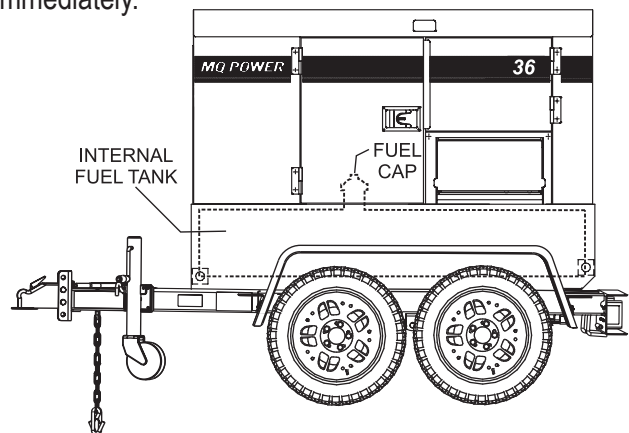

Figure 17. Fuel Tank

INSPECTION/SETUP

Refueling Procedure

⚠ WARNING



Diesel fuel and its vapors are dangerous to your health and the surrounding environment. Avoid skin contact and/or inhaling fumes.

1. **Level Tanks** — Make sure fuel cells are level with the ground. Failure to do so will cause fuel to spill from the tank before reaching full capacity (Figure 18).

⚠ CAUTION

ALWAYS place trailer on firm level ground before refueling to prevent spilling and maximize the amount of fuel that can be pumped into the tank.

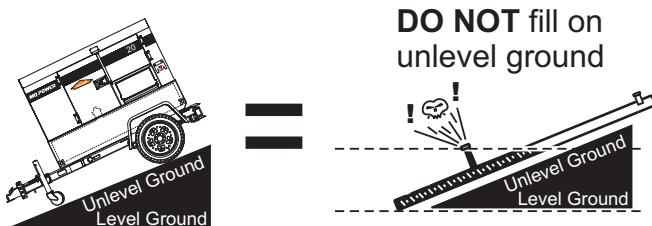

Figure 18. Only Fill On Level Ground

NOTICE

ONLY use #2 diesel fuel when refueling.

2. Open cabinet doors on the “right side” of the generator (from generator control panel position). Remove fuel cap and fill tank (Figure 19).

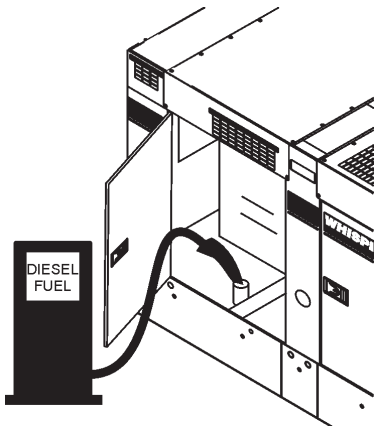

Figure 19. Fueling The Generator

3. **NEVER overfill fuel tank** — It is important to read the fuel gauge when filling trailer fuel tank. **DO NOT** wait for fuel to rise in filler neck (Figure 20).

FUEL GAUGE LOCATED ON CONTROL PANEL

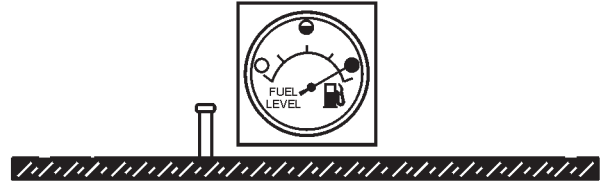

Figure 20. Full Fuel Tank

⚠ CAUTION

DO NOT OVERFILL fuel system. Leave room for fuel expansion. Fuel expands when heated (Figure 21).



Figure 21. Fuel Expansion

COOLANT (ANTIFREEZE/SUMMER COOLANT/WATER)

Isuzu recommends antifreeze/summer coolant for use in their engines, which can be purchased in concentrate (and mixed with 50% demineralized water) or pre-diluted. See the **Isuzu Engine Owner's Manual** for further details.

⚠ WARNING



If adding coolant/antifreeze mix to the radiator, **DO NOT** remove the radiator cap until the unit has completely cooled. The possibility of **hot!** coolant exists which can cause severe burns.

Day-to-day addition of coolant is done from the recovery tank. When adding coolant to the radiator, **DO NOT** remove the radiator cap until the unit has completely cooled. See Table 8 for engine, radiator, and recovery tank coolant capacities.

NOTICE

Normally, only the coolant level in the recovery tank needs to be checked. However, the radiator cap should be opened once a week to verify that coolant is visible (full) inside the radiator.

1. Verify that the coolant level in the coolant recovery tank is between the **FULL** and **LOW** markings as shown in Figure 22.

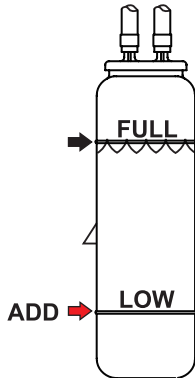

Figure 22. Coolant Recovery Tank

Table 8. Coolant Capacity

Engine and Radiator	4.5 gal (16.8 liters)
Reserve Tank	0.24 gal (0.9 liters)

Operation In Freezing Weather

When operating in freezing weather, be certain the proper amount of antifreeze (Table 9) has been added.

Table 9. Antifreeze Operating Temperatures

Vol. % Antifreeze	Freezing Point	
	°C	°F
50	-37	-34

NOTICE

When the antifreeze is mixed with water, the antifreeze mixing ratio **must be** less than 50%.

Cleaning The Radiator

The engine may overheat if the radiator fins become overloaded with dust or debris. Periodically clean the radiator fins with compressed air. Cleaning inside the machine is dangerous, so clean only with the engine turned off and the **negative** battery terminal disconnected.

AIR CLEANER

Periodic cleaning/replacement is necessary. Inspect air cleaner in accordance with the **Isuzu Engine Owner's Manual**.

FAN BELT TENSION

A slack fan belt may contribute to overheating, or to insufficient charging of the battery. Inspect the fan belt for damage and wear and adjust it in accordance with the **Isuzu Engine Owner's Manual**.

The fan belt tension is proper if the fan belt bends 10 to 15 mm (Figure 23) when depressed with the thumb as shown below.

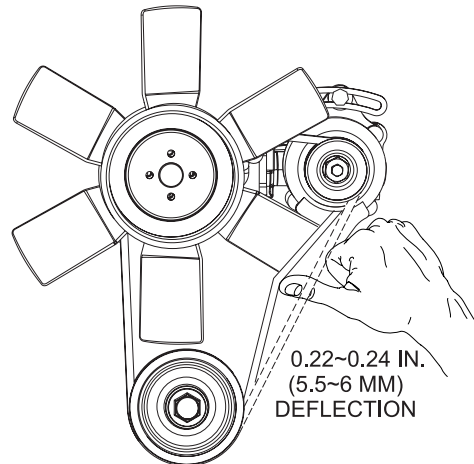

Figure 23. Fan Belt Tension

CAUTION



NEVER place hands near the belts or fan while the generator set is running.

BATTERY

This unit is of negative ground **DO NOT** connect in reverse. Always maintain battery fluid level between the specified marks. Battery life will be shortened, if the fluid level is not properly maintained. Add only distilled water when replenishment is necessary.

DO NOT overfill. Check to see whether the battery cables are loose. Poor contact may result in poor starting or malfunctions. **Always** keep the terminals firmly tightened. Coating the terminals with an approved battery terminal treatment compound. Replace battery with only recommended type battery. The battery type used in this generator is BCI Group 27.

The battery is sufficiently charged if the specific gravity of the battery fluid is 1.28 (at 68° F). If the specific gravity should fall to 1.245 or lower, it indicates that the battery is dead and needs to be recharged or replaced.

Before charging the battery with an external electric source, be sure to disconnect the battery cables.

Battery Cable Installation

ALWAYS be sure the battery cables (Figure 24) are properly connected to the battery terminals as shown below. The **red cable** is connected to the positive terminal of the battery, and the **black cable** is connected to the negative terminal of the battery.

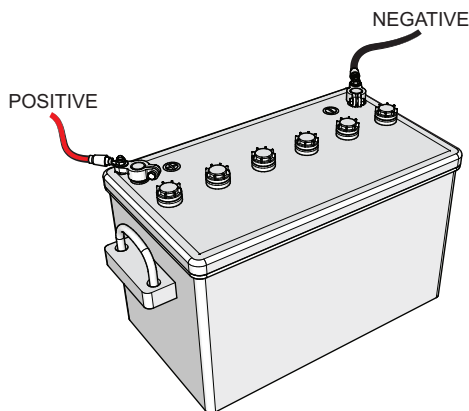
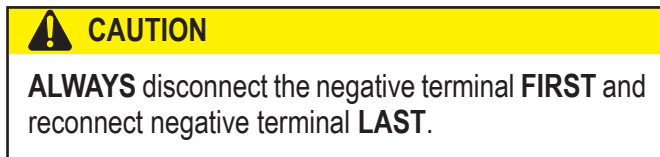

Figure 24. Battery Connections

When connecting battery do the following:

1. **NEVER** connect the battery cables to the battery terminals when the **Auto-Off/Reset-Manual Switch** is in either the **AUTO** or **MANUAL** position. **ALWAYS** make sure that this switch is in the **OFF/RESET** position when connecting the battery.
2. Place a small amount of battery terminal treatment compound around both battery terminals. This will ensure a good connection and will help prevent corrosion around the battery terminals.

NOTICE

If the battery cable is connected incorrectly, electrical damage to the generator will occur. Pay close attention to the polarity of the battery when connecting the battery.

CAUTION

Inadequate battery connections may cause poor starting of the generator, and create other malfunctions.

ALTERNATOR

The polarity of the alternator is negative grounding type. When an inverted circuit connection takes place, the circuit will be in short circuit instantaneously resulting the alternator failure.

DO NOT put water directly on the alternator. Entry of water into the alternator can cause corrosion and damage the alternator.

WIRING

Inspect the entire generator for bad or worn electrical wiring or connections. If any wiring or connections are exposed (insulation missing) replace wiring immediately.

PIPING AND HOSE CONNECTION

Inspect all piping, oil hose, and fuel hose connections for wear and tightness. Tighten all hose clamps and check hoses for leaks.

If any hose (**fuel or oil**) lines are defective, replace them immediately.

GENERATOR START-UP PROCEDURE (MANUAL MODE)

BEFORE STARTING

CAUTION

The engine's exhaust contains harmful emissions. **ALWAYS** have adequate ventilation when operating. Direct exhaust away from nearby personnel.

WARNING

NEVER manually start the engine with the main, GFCI or auxiliary circuit breakers in the **ON** (closed) position.

1. Place the **main, GFCI, and aux.** circuit breakers (Figure 25) in the **OFF** position prior to starting the engine.

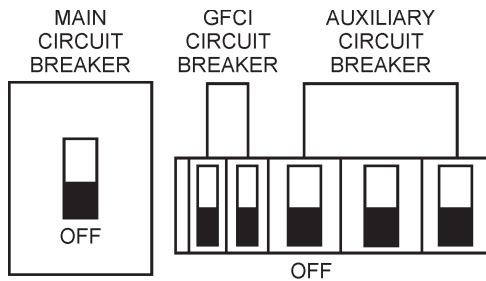

Figure 25. Main, Aux. and GFCI Circuit Breakers (OFF)

2. Connect the load to the **receptacles** or the **output terminal lugs** as shown in Figure 10. Tighten terminal nuts securely to prevent load wires from slipping out.
3. Close all engine enclosure doors (Figure 26).

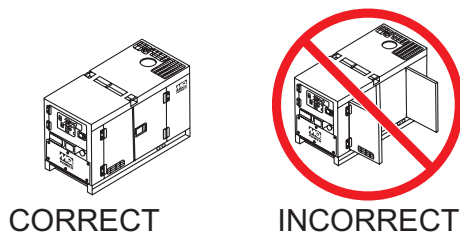

Figure 26. Engine Enclosure Doors

STARTING (MANUAL)

1. On the control box, place the diagnostic switch (Figure 28) in the **OFF** (down) position.



Figure 27. Diagnostic Switch (High)

2. Place the engine speed switch (Figure 28) in the **LOW** (down) position.



Figure 28. Engine Speed Switch (Low)

3. Place the **Auto Start/Stop switch** in the **MANUAL** position to start the engine (Figure 29).



Figure 29. Auto Start/Stop Switch (Manual Position)

4. Depending on the temperature of the coolant (cold weather conditions), the pre-heat lamp (Figure 30) will light (**ON**) and remain on until the pre-heating cycle has been completed. After completion of the pre-heating cycle, the light will go **OFF** and the engine will start up automatically.

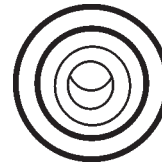

Figure 30. Pre-Heat Lamp

5. Once the engine starts, let the engine run for 1-2 minutes (let engine idle longer in cold weather conditions). Listen for any abnormal noises. If any abnormalities exist, shut down the engine and correct the problem.

NOTICE

In cold weather conditions warm up the engine 5-7 minutes before placing into operation.

6. Verify that the engine started status LED on the ECU controller is on.

NOTICE

If the engine fails to start after 3 attempts, the over-crank LED on the ECU controller will turn on and the Auto Start/Stop switch must be placed in the Off/Reset position before the engine can be restarted.

GENERATOR START-UP PROCEDURE (MANUAL MODE)

7. If the engine is running smoothly, place the engine speed switch (Figure 31) in the **HIGH** (up) position.



Figure 31. Engine Speed Switch (High)

8. The generator's frequency meter (Figure 32) should be displaying the 60 cycle output frequency in **HERTZ**.

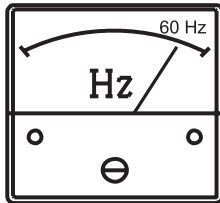

Figure 32. Frequency Meter

9. The generator's AC-voltmeter (Figure 33) will display the generator's output in **VOLTS**.

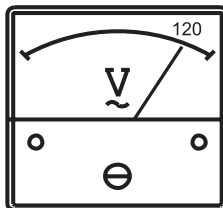

Figure 33. Voltmeter

10. If the voltage is not within the specified tolerance, use the voltage regulator (Figure 34) to increase or decrease the desired voltage.



Figure 34. Voltage Regulator

11. The ammeter (Figure 35) will indicate **zero amps** with no load applied. When a load is applied, the ammeter will indicate the amount of current that the load is drawing from the generator.

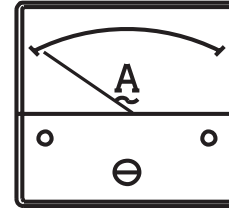

Figure 35. Ammeter (No Load)

12. The engine oil pressure gauge (Figure 36) will indicate the oil pressure of the engine. Under normal operating conditions the oil pressure is approximately 50 psi. (345 kPa).

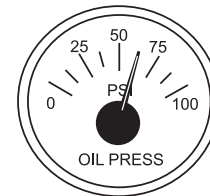

Figure 36. Oil Pressure Gauge

13. The **coolant temperature gauge** (Figure 37) will indicate the coolant temperature. Under normal operating conditions, the coolant temperature should be approximately 180°F (82°C).

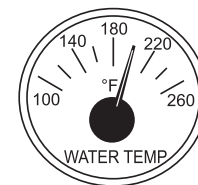

Figure 37. Coolant Temperature Gauge

14. The **tachometer gauge** (Figure 38) will indicate the speed of the engine when the generator is operating. Under normal operating conditions, this speed is approximately 1,800 rpm.

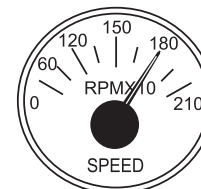

Figure 38. Engine Tachometer Gauge

GENERATOR START-UP PROCEDURE (MANUAL MODE)

15. Place the **main, GFCI, and aux.** circuit breakers in the **ON** position (Figure 39).

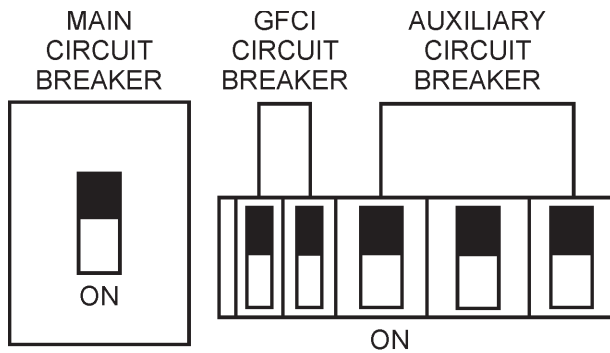

Figure 39. Main, Aux. and GFCI Circuit Breakers (ON)

16. Observe the generator's ammeter (Figure 40) and verify it reads the anticipated amount of current with respect to the load. The ammeter will only display a current reading if a load is in use.

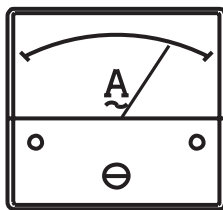

Figure 40. Ammeter (Load)

17. The generator will run until manually stopped or an abnormal condition occurs.

GENERATOR START-UP PROCEDURE (AUTO MODE)

DANGER



Before connecting this generator to any building's electrical system, a **licensed electrician** must install an **isolation (transfer) switch**. Serious damage to the building's electrical system may occur without this transfer switch.

NOTICE

When connecting the generator to a isolation (transfer) switch, **ALWAYS** have power applied to the generator's internal battery charger. This will ensure that the engine will not fail due to a dead battery.

NOTICE

When the **Auto Start/Stop** switch is placed in the **AUTO** mode, the generator will **automatically start** in the event of commercial power falling below a prescribed level by means of a contact closure that is generated automatically by a transfer switch.

In this position (**AUTO**), should an outage occur, the automatic transfer switch (ATS) will start the generator automatically via the generator's auto-start contacts connected to the ATS's start contacts.

Please refer to your ATS installation manual for further instructions for the correct installation of the auto-start contacts of the generator to the ATS.

WARNING

When running the generator in the **AUTO** mode, remember the generator can start up at any time without warning. **NEVER** attempt to perform any maintenance when the generator is in the auto mode.

NOTICE

When the **Auto Start/Stop** switch is placed in the **AUTO** position, the engine glow plugs will be warmed and the engine will start automatically.

NOTICE

The engine speed switch **must** be set to the "High" position when running in the **auto-start** mode. Failing to set the switch in the proper position can result in damage to your generator when it turns on.

STARTING (AUTO MODE)

When starting generator in **AUTO** mode use the "Manual Start-up" procedure except where noted (see below).

1. Perform steps 1 through 5 in the Before Starting section as outlined in the Manual Starting Procedure.
2. Place the **Auto Start/Stop switch** (Figure 41) in the **AUTO** position.



Figure 41. Auto Start/Stop Switch (AUTO)

3. Continue operating the generator as outlined in the Manual Start-up procedure (start at step 7).

GENERATOR SHUTDOWN PROCEDURES

WARNING

NEVER stop the engine suddenly except in an emergency.

NORMAL SHUTDOWN PROCEDURE

To shut down the generator, use the following procedure:

1. Place both the **MAIN, GFCI and LOAD** circuit breakers as shown in Figure 42 to the **OFF** position.

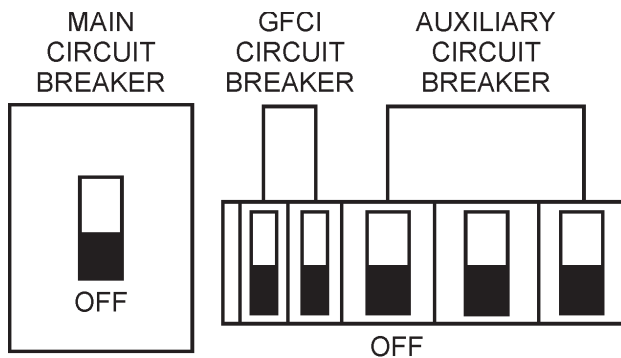

Figure 42. Main, Aux. and GFCI Circuit Breakers (OFF)

2. Let the engine cool by running it at low speed for 3-5 minutes with no load applied.
3. Place the **Auto Start/Stop switch** (Figure 43) in the **OFF/RESET** position.



Figure 43. Auto Start/Stop Switch (Off/Reset)

4. Verify that all status LEDs on the ECU control panel are **OFF** (not lit).
5. Remove all loads from the generator.
6. Inspect entire generator for any damage or loosening of components that may have occurred during operation.

EMERGENCY SHUTDOWN PROCEDURE

NOTICE

The Emergency Stop switch should only be used to stop the engine in case of an emergency or to lock out operation during service. The emergency stop switch should **NEVER** be used for routine stopping of the engine.

1. To stop the engine in the event of an emergency, push the **Emergency Stop switch** (Figure 44).

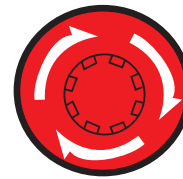

Figure 44. Emergency Stop Switch

2. The emergency stop switch is a push-locked type switch. The switch contact can only be released by rotating the button in the clockwise direction. The engine can not be restarted until the contact is released (**closed**).
3. Place the **MAIN, GFCI and LOAD** circuit breakers as shown in Figure 42 to the **OFF** position.

AUTOMATIC SHUTDOWN SYSTEM

This unit is equipped with safety devices to automatically stop the engine in the event of low oil pressure, approximately 14 psi (97 kPa), high water temperature, approximately 212°F (100°C), or overspeed approximately +15%. The alarm lamps on the ECU illuminate to signify the reason for the shutdown.

NOTICE

Before inspecting the generator, check that the Auto Start/Stop switch is in the **OFF/RESET** position, and place all circuit breakers in the **OFF** position. Allow sufficient time for adequate cooling. When ready to restart, complete all steps in the Generator Start-up Procedure section of this manual.

MAINTENANCE

Table 10. Inspection/Maintenance		10 Hours/ DAILY	250 Hours	500 Hours or Every 12 Months	3,000 Hours or Every 36 Months	OTHER
Engine	Check Engine Oil and Coolant Levels	X				
	Check Fuel Filter/Water Separator Bowl	X				
	Check Air Cleaner/Element	X				
	Exhaust System* ⁵		X			
	Check for Leaks/Hoses/Clamps* ⁴	X				
	Check for Loosening of Parts	X				
	Change Engine Oil and Oil Filter * ¹		X			
	Clean Unit, Inside and Outside		X			
	Replace Fuel Filter Elements			X		
	Check Engine Mounts			X		
	Service Battery			X		
	Check Air Intake Hoses			X		
	Check Fan Belt Condition			X		
	Check Automatic Belt Tensioner			X		
	Check Electrical Ground Connection			X		
	Clean Radiator, Check Cooling System			X		
	Coolant Solution Analysis, Add SCA's As Required			X		
	Pressure Test Cooling System			X		
	Check Engine Speed			X		
	Test Thermostats				X	
	Check and Adjust Engine Valve Clearance				X	
	Test Glow Plugs				X	
	Flush and Refill Cooling System* ²					2 years or 2,000 hours
Clean Inside of Fuel Tank					1,000 hours	
Check Crankcase Ventilation Filter					1,500 hours	
Replace Air Cleaner Elements * ³					As Required	
Generator	Measure Insulation Resistance Over 3M ohms		X			
	Check Rotor Rear Support Bearing			X		

*¹ During initial operation of a new engine, change oil and filter between a minimum of 100 hours and a maximum of 250 hours. Service interval depends on type of oil.

*² Add Supplemental Coolant Additives (SCAs) to recharge the engine coolant.

*³ Replace primary air filter element when restriction indicator shows a vacuum of 625 mm (25 in. H₂O).

*⁴ If blowby hose needs to be replaced, ensure that the slope of the blowby hose is at least a 1/2 inch per foot, with no sags or dips that could collect moisture and/or oil.

*⁵ Accumulation of carbon (soot, unburned fuel) in the exhaust pipe line and muffler could cause not only system derates but also could lead to fire incident. To destroy the soot and unburned fuel, run the unit at rated power for some period of time until the exhaust gas become mostly colorless every 250 hours operation time. The carbon will be easier to be generated when the unit operates at less then 30% of rated power. In this case, perform the above procedures at shorter interval time.

NOTICE

Before inspecting generator, check that the Auto Start/Stop switch is in the **OFF/RESET** position, and place all circuit breakers in the **OFF** position. Allow sufficient time for adequate cooling. When ready to restart, complete all steps in the Generator Start-up Procedure section of this manual.

GENERAL INSPECTION

Prior to each use, the generator should be cleaned and inspected for deficiencies. Check for loose, missing or damaged nuts, bolts or other fasteners. Also check for fuel, oil, and coolant leaks. Use Table 10 as a general maintenance guideline. For more detailed engine maintenance instructions, refer to the engine owner's manual.

AIR CLEANER

Every 250 hours: Remove air cleaner element (Figure 45) and clean the heavy duty paper element with light spray of compressed air. Replace the air cleaner as needed.

Air Cleaner with Dust Indicator

This indicator (Figure 45) is attached to the air cleaner. When the air cleaner element is clogged, air intake restriction becomes greater and the dust indicator signal shows **RED** meaning the element needs changing or service. After changing the air element, press the dust indicator button to reset the indicator.

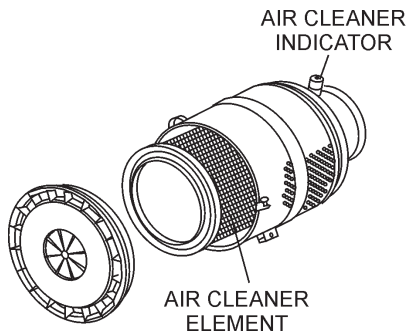

Figure 45. Air Cleaner/Indicator

NOTICE

The air filter should not be changed until the indicator reads "**RED**". Dispose of old air filter. It may not be cleaned or reused.

If the engine is operating in very **dusty** or **dry grass** conditions, a clogged air cleaner will result. This can lead to a loss of power, excessive carbon buildup in the combustion chamber and high fuel consumption. Change air cleaner more **frequently** if these conditions exist.

FUEL ADDITION

Add diesel fuel (the grade may vary according to season and locations).

Removing Water from the Fuel Tank

After prolonged use, water and other impurities accumulate in the bottom of the tank. Occasionally inspect the fuel tank for water contamination and drain the contents if required.

During cold weather, the more empty volume inside the tank, the easier it is for water to condense. This can be reduced by keeping the tank full with diesel fuel.

Cleaning Inside the Fuel Tank

Drain the fuel inside the fuel tank completely. Using a spray washer (Figure 46) wash out any deposits or debris that have accumulated inside the fuel tank.

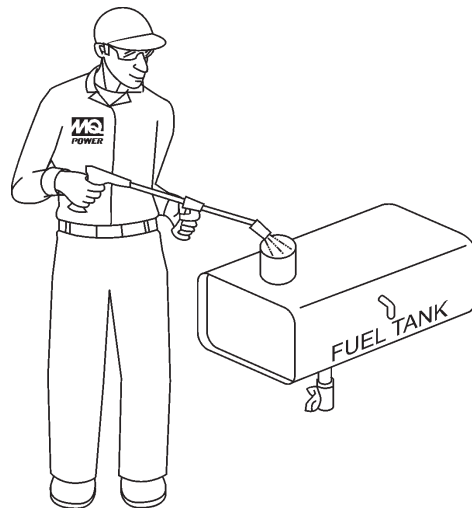

Figure 46. Fuel Tank Cleaning

FUEL TANK INSPECTION

In addition to cleaning the fuel tank, the following components should be inspected for wear:

- **Rubber Suspension** — look for signs of wear or deformity due to contact with oil. Replace the rubber suspension if necessary.
- **Fuel Hoses** — inspect nylon and rubber hoses for signs of wear, deterioration and hardening.
- **Fuel Tank Lining** — inspect the fuel tank lining for signs of excessive amounts of oil or other foreign matter.

Replacing Fuel Filter

- Replace the fuel filter cartridge with new one every 500 hours or so.
- Loosen the drain plug at the lower top of the fuel filter. Drain the fuel in the fuel body together with the mixed water. **DO NOT** spill the fuel during disassembly.
- Vent any air.

AIR REMOVAL

If air enters the fuel injection system of a diesel engine, starting becomes impossible. After running out of fuel, or after disassembling the fuel system, bleed the system according to the following procedure. See the **Isuzu Engine Manual** for details.

To restart after running out of fuel, turn the switch to the **ON** position for 15–30 seconds. Try again, if needed. This unit is equipped with an automatic air bleeding system.

EMISSION CONTROL

Diesel Oxidation Catalyst (DOC)

The DOC does not filter particles it oxidizes them. This catalyst (honeycomb like structure) uses a chemical process to break down pollutants in the exhaust stream into less harmful components. In general, this catalyst collects/burns accumulated particulates. The DOC contains palladium and platinum which serve as a catalysts to oxidize hydrocarbons and carbon monoxide. Replace DOC as required.

CHECK OIL LEVEL

Check the crankcase oil level prior to each use, or when the fuel tank is filled. Insufficient oil may cause severe damage to the engine. Make sure the generator is level. The oil level must be between the two notches on the dipstick as shown in Figure 16.

Replacing Oil Filter

- Remove the old oil filter.
- Apply a film of oil to the gasket on the new oil filter.
- Install the new oil filter.
- After the oil cartridge has been replaced, the engine oil will drop slightly. Run the engine for a while and check for leaks before adding more oil if needed. Clean excessive oil from engine.

FLUSHING OUT RADIATOR AND REPLACING COOLANT

- Open both cocks located at the crankcase side and at the lower part of the radiator and drain coolant. Open the radiator cap while draining. Remove the overflow tank and drain.
- Check hoses for softening and kinks. Check clamps for signs of leakage.
- Tighten both cocks and replace the overflow tank.
- Replace with coolant as recommended by the engine manufacturer.
- Close radiator cap tightly.
- Flush the radiator by running clean tap water through radiator until signs of rust and dirt are removed. **DO NOT** clean radiator core with any objects, such as a screwdriver.

WARNING



Allow engine to **cool** when flushing out radiator. Flushing the radiator while hot could cause serious burns from water or steam.

RADIATOR CLEANING

The radiator (Figure 47) should be sprayed (cleaned) with a high pressure washer when excessive amounts of dirt and debris have accumulated on the cooling fins or tube. When using a high pressure washer, stand at least 5 feet (1.5 meters) away from the radiator to prevent damage to the fins and tube.

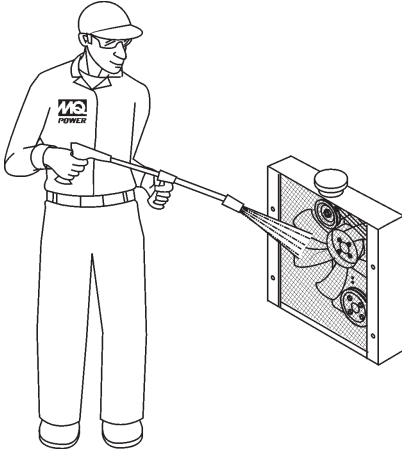

Figure 47. Radiator Cleaning

TESTING THE GFCI RECEPTACLE

NOTICE

The GFCI receptacle is designed to interrupt power when a ground fault exists to prevent injuries and shock hazards. **DO NOT** use the GFCI receptacle if the test below fails. Consult a qualified electrician for repair or replacement of the GFCI receptacle. Test the GFCI receptacle **at least once a month**.

1. Start the generator as outlined in the start-up procedure in this manual.
2. Place a GFCI circuit breaker (Figure 48) in the **ON** position.

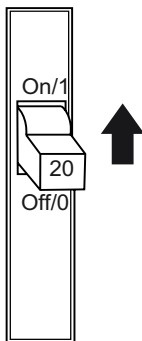

Figure 48. GFCI Circuit Breaker

3. Verify that the status LED on the corresponding GFCI receptacle (Figure 49) is **ON (GREEN)**.

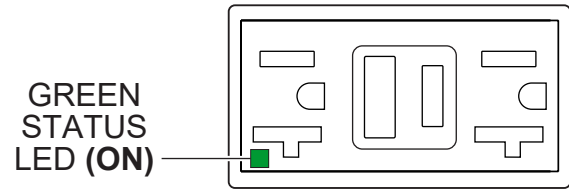

Figure 49. GFCI Receptacle (ON)

4. Press the **TEST** button (Figure 50) on the GFCI receptacle and verify that the status LED turns **OFF**.

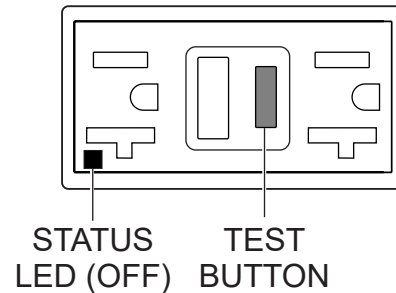

Figure 50. GFCI Receptacle (OFF)

5. Press the **RESET** button (Figure 51) to restore power to the GFCI receptacle and verify that the status LED is **ON (GREEN)**.

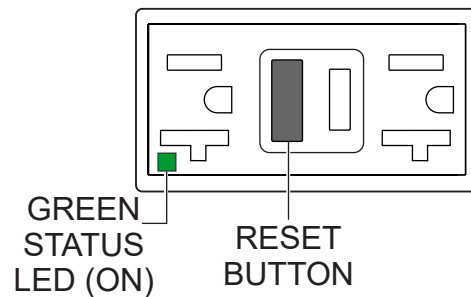

Figure 51. GFCI Receptacle (ON/Restore)

6. If the status LED (Figure 52) is **flashing (RED)**, **DO NOT** use the GFCI receptacle and replace it immediately.

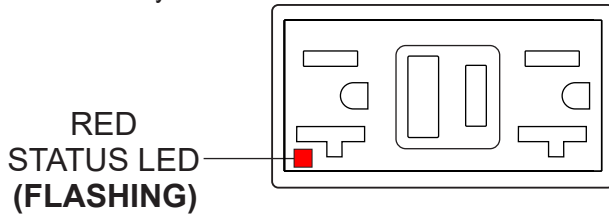

Figure 52. GFCI Receptacle (Red Flashing LED)

7. Repeat the above procedure for any other GFCI receptacles.

GENERATOR STORAGE

For long-term storage of the generator the following is recommended:

- Drain the fuel tank completely. Treat with a fuel stabilizer if necessary.
- Completely drain the oil from the crankcase and refill if necessary with fresh oil.
- Clean the entire generator, internal and external.
- Cover the generating set and store in a clean, dry place.
- Disconnect the battery.
- Make sure engine coolant is at proper level.
- If generator is mounted on a trailer, jack trailer up and place on blocks so tires do not touch the ground or block and completely remove the tires.

MAINTENANCE

ENGINE BLOCK HEATER AND INTERNAL BATTERY CHARGER 120 VAC INPUT RECEPTACLES (OPTIONAL)

This generator can be optionally equipped with a 120 VAC, 20-amp input receptacle located on the output terminal panel.

The purpose of this receptacle is to provide power via commercial power to the internal battery charger and engine block heater.

This receptacle will **ONLY** function when commercial power has been supplied to it (Figure 53). To apply commercial power to this receptacle, a power cord of adequate size will be required (See Table 6).

When using the generator in **hot** climates there is no reason to apply power to engine block heater. However, if the generator will be used in **cold** climates, it is always a good idea to apply power to the heating element at all times.

If the generator will be used daily, the battery should normally not require charging. If the generator will be idle (not used) for long periods of time, apply power to the battery charger receptacle via commercial power using a power cord of adequate size.

NOTICE

If the generator will be idle (not used) for long periods of time and to ensure adequate starting capability, always have power applied to the generator's internal battery charger.

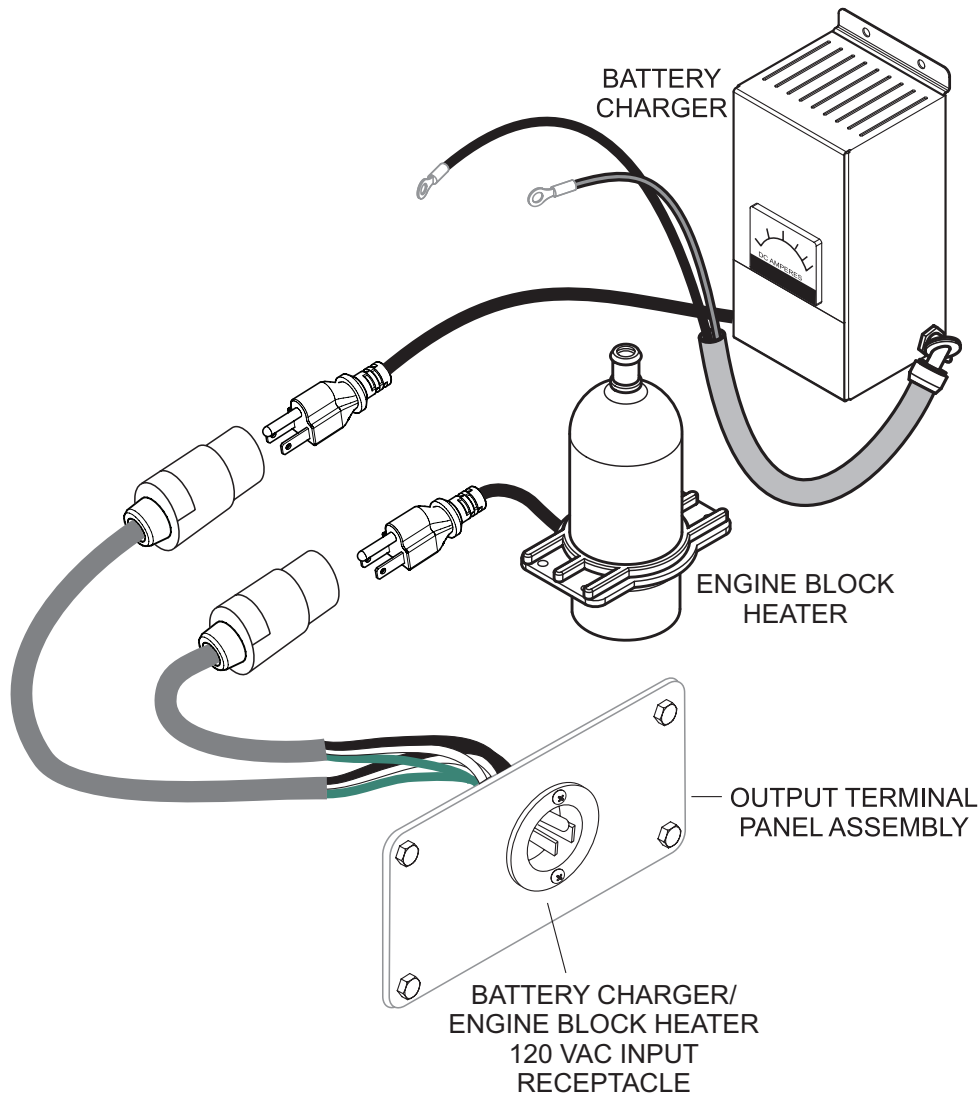

Figure 53. Battery Charger And Engine Block Heater Power Connections

EMISSION CONTROL

The emission control system employed with the Isuzu 4LE2X diesel engine consists of a Diesel Oxidation Catalyst (DOC).

This device oxidizes large amounts of harmful nitrogen oxides (NOx) and particulate matter (PM) which are emitted by diesel engines. These exhaust emissions pose serious environmental and health risks. No maintenance or service is required for the DOC device used on this generator.

Diesel Oxidation Catalyst (DOC)

The DOC (Figure 54) does not filter particles, it oxidizes them. This catalyst (honeycomb-like structure) uses a chemical process to break down pollutants in the exhaust stream into less harmful components. In general this catalyst collects/burns accumulated particulates. The DOC contains palladium and platinum which serve as catalysts to oxidize hydrocarbons and carbon monoxide.

PREVENTIVE MAINTENANCE PROGRAMS

Most challenging to a rental organization is the fact that a customer's power assumptions may not meet the minimum load requirements of the power equipment selected. When in doubt, it is always recommended to apply a **load bank application** to the equipment following a longer rental period.

Equipment on extended, long-term contracts needs periodic on-site inspection. If possible, interview the operator and survey the equipment hooked up to the generator to estimate load conditions.

Preventive maintenance and a few extra steps prevent downtime and protect your investment and business. A well-planned preventive maintenance program will reward you with years of service.

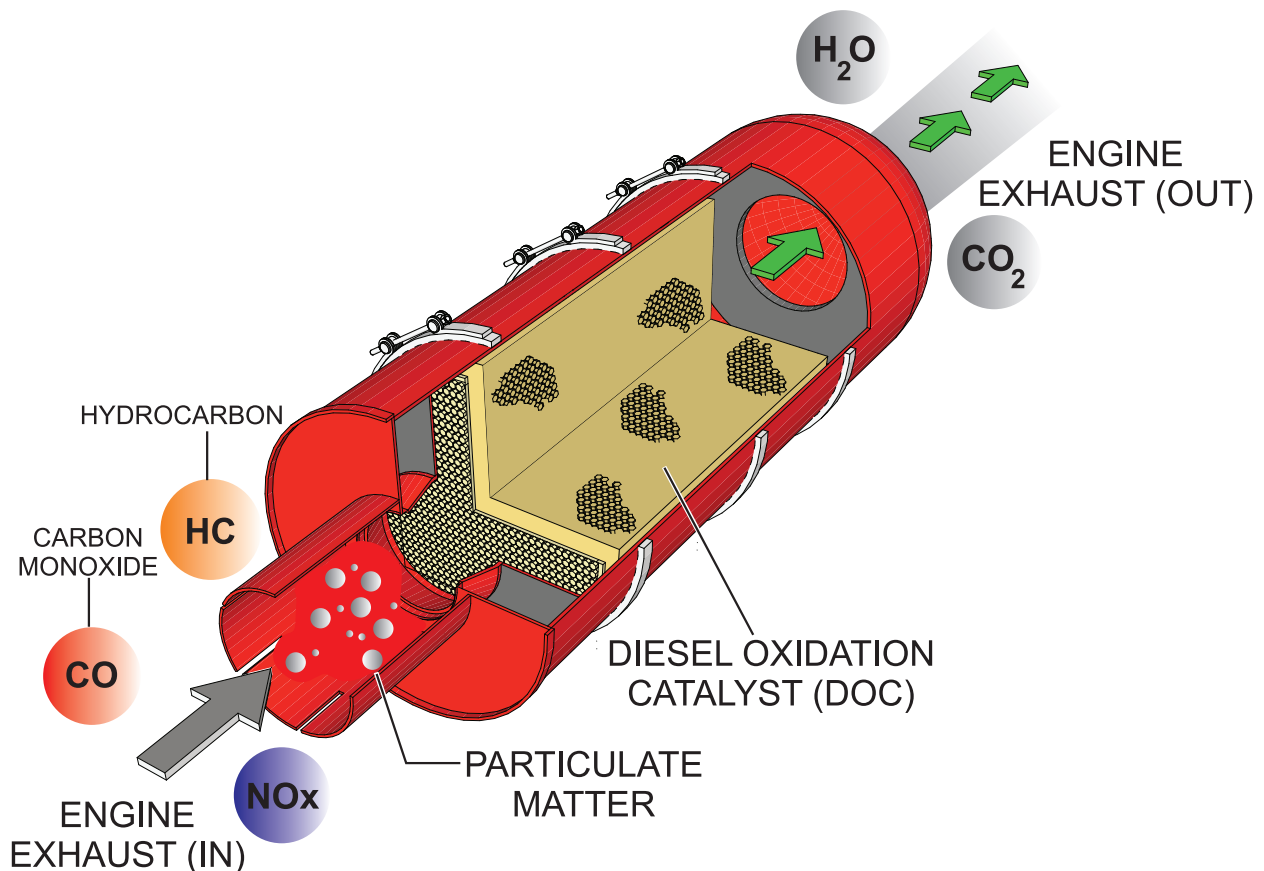

Figure 54. Diesel Oxidation Catalyst (DOC)

TROUBLESHOOTING (DIAGNOSTICS)

The engine controller of this generator diagnoses problems that arise from the engine control system and the engine itself. Press the diagnostic button on the diagnostic panel (Figure 55) to determine if an engine malfunction has occurred.

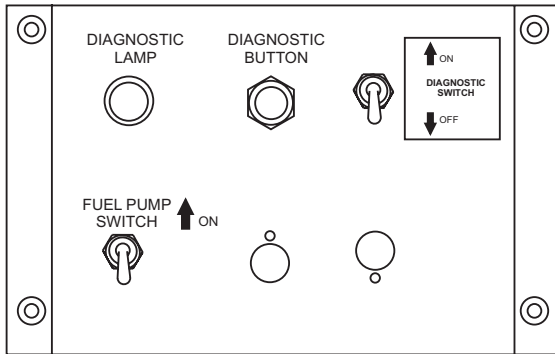

Figure 55. Diagnostic Panel

ENGINE FAULT CODE DIAGNOSTIC PROCEDURES

1. Remove all loads from the generator and place all circuit breakers in the **OFF** position.
2. Shut down the engine and open the control panel.
3. On the control panel, place the **diagnostic switch** in the **ON** (up) position to start the diagnostic process.
4. The diagnostic lamp will light continuously indicating that there is a fault error in the engine or the engine control system.
5. Push and hold the diagnostic button (Figure 56) to identify the fault.

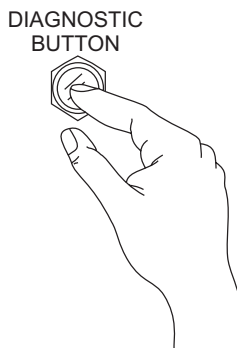

Figure 56. Diagnostic Button

6. The following will occur:
 - The diagnostic lamp will start blinking with a pattern associated with the fault 3 times at an interval of 2.4 seconds.
 - If there are more than 2 fault codes are detected, the diagnostic lamp will repeat the detected fault codes blinking patterns in ascending order. After all the detected fault codes are shown, it will repeat the same sequence from the beginning.
 - If no fault code is detected, the diagnostic lamp will blink repeatedly at an interval of 2.4 seconds.

NOTICE

- When a fault has been detected, the fault code will automatically be saved as a previous code in the **ECM** even after the fault has been repaired.
- The diagnostic lamp indicates the current fault code with the previous fault code in ascending order.
- When a fault occurs while the engine is running, the diagnostic lamp will turn on indicating only the **current fault** has occurred. Please note that the blinking fault code pattern cannot be displayed while the engine is running.

NOTICE

For a complete understanding of error codes and troubleshooting procedures, refer to the enclosed engine instruction manual.

TROUBLESHOOTING (GENERATOR)

Practically all breakdowns can be prevented by proper handling and maintenance inspections, but in the event of a breakdown, use Table 11 shown below for diagnosis of the generator. If the problem cannot be remedied, consult our company's business office or service plant.

Table 11. Generator Troubleshooting		
Symptom	Possible Problem	Solution
No Voltage Output	Defective AC voltmeter?	Check output voltage and replace if necessary.
	Loose wiring connection?	Check wiring and repair.
	Defective AVR?	Replace if necessary.
	Defective rotating rectifier?	Check and replace.
Low Voltage Output	Loose wiring connection?	Check wiring and repair.
	Defective AVR?	Replace if necessary.
High Voltage Output	Loose wiring connection?	Check wiring and repair.
	Defective AVR?	Replace if necessary.
Circuit Breaker Tripped	Short circuit in load?	Check load and repair.
	Over current?	Confirm load requirement and reduce.
	Defective circuit breaker?	Check and replace.
	Overcurrent relay actuated?	Confirm load requirement and reset.

TROUBLESHOOTING (ENGINE)

Troubleshooting (Engine)		
Symptom	Possible Problem	Solution
Engine will not start or start is delayed, although engine can be turned over.	No fuel reaching injection pump?	Add fuel. Check entire fuel system.
	Defective fuel pump?	Replace fuel pump.
	Fuel filter clogged?	Replace fuel filter and clean tank.
	Faulty fuel supply line?	Replace or repair fuel line.
	Compression too low?	Check piston, cylinder and valves. Adjust or repair per engine repair manual.
	Fuel pump not working correctly?	Repair or replace fuel pump.
	Oil pressure too low?	Check engine oil pressure.
	Low starting temperature limit exceeded?	Comply with cold starting instructions and proper oil viscosity.
	Defective battery?	Charge or replace battery.
	Air or water mixed in fuel system?	Check carefully for loosened fuel line coupling, loose cap nut, etc.
At low temperatures engine will not start.	Engine oil too thick?	Refill engine crankcase with correct type of oil for winter environment.
	Defective battery?	Replace battery.
Engine fires but stops as soon as starter is switched off.	Fuel filter blocked?	Replace fuel filter.
	Fuel supply blocked?	Check the entire fuel system.
	Defective fuel pump?	Replace fuel pump.
Engine stops by itself during normal operation.	Fuel tank empty?	Add fuel.
	Fuel filter blocked?	Replace fuel filter.
	Defective fuel pump?	Replace fuel pump.
	Mechanical oil pressure shutdown sensor stops the engine due to low oil?	Add oil. Replace low oil shutdown sensor if necessary.
Low engine power, output and speed.	Fuel tank empty?	Add fuel.
	Fuel filter clogged?	Replace fuel filter.
	Fuel tank venting is inadequate?	Ensure tank is adequately vented.
	Leaks at pipe unions?	Check threaded pipe unions. Tape and tighten unions as required.
	Speed control lever does not remain in selected position?	See engine manual for corrective action.
	Engine oil level too full?	Correct engine oil level.
	Injection pump wear?	Use No. 2-D diesel fuel only. Check the fuel injection pump element and delivery valve assembly and replace as necessary.

TROUBLESHOOTING (ENGINE)

Troubleshooting (Engine) - continued		
Symptom	Possible Problem	Solution
Low engine power output and low speed, black exhaust smoke.	Air filter blocked?	Clean or replace air filter.
	Incorrect valve clearances?	Adjust valves per engine specification.
	Malfunction at injector?	See engine manual.
Engine overheats.	Too much oil in engine crankcase?	Drain off engine oil down to upper mark on dipstick.
	Entire cooling air system contaminated or blocked?	Clean cooling air system and cooling fin areas.
	Fan belt broken or elongated?	Change belt or adjust belt tension.
	Coolant insufficient?	Replenish coolant.
	Radiator net or radiator fin clogged with dust?	Clean net or fin carefully.
	Fan, radiator, or radiator cap defective?	Replace defective part.
	Thermostat defective?	Check thermostat and replace if necessary.
Head gasket defective or water leakage?	Replace parts.	

GENERATOR WIRING DIAGRAM (M184000503A)

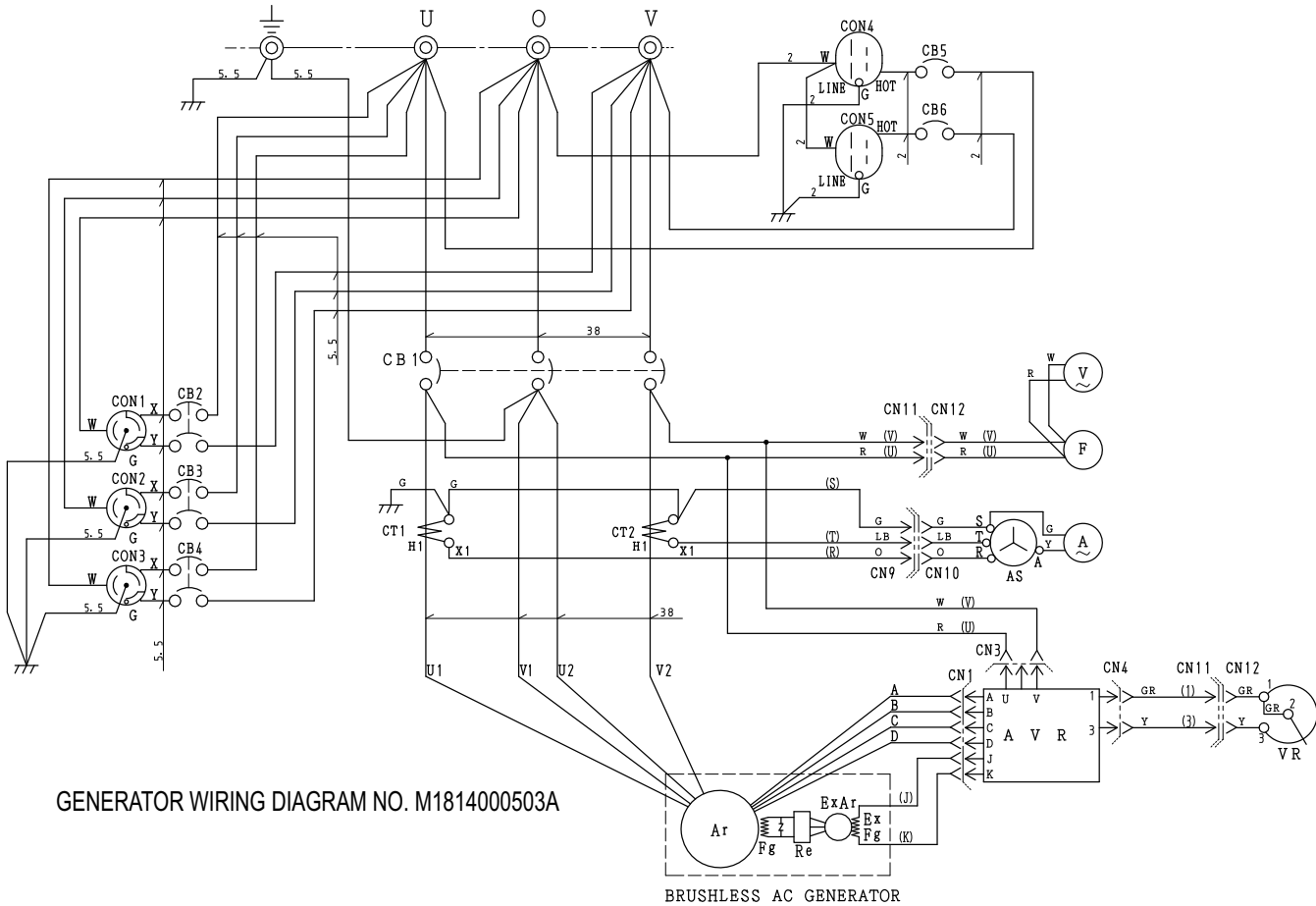

GENERATOR WIRING DIAGRAM NO. M1814000503A

BRUSHLESS AC GENERATOR

COLOR CODE			
WIRE COLOR	WIRE COLOR	WIRE COLOR	WIRE COLOR
B	BLACK	R	RED
L	BLUE	W	WHITE
BR	BROWN	Y	YELLOW
G	GREEN	LB	LIGHT BLUE
GR	GRAY	LG	LIGHT GREEN
V	VIOLET	O	ORANGE
P	PINK		

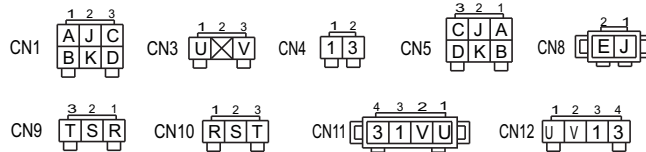

CONNECTOR ARRANGEMENT (WIRING VIEW)

SYMBOL	DESIGNATION
Ar	MAIN GENERATOR ARMATURE WINDING
Fg	MAIN GENERATOR FIELD WINDING
ExAr	EXCITER ARMATURE WINDING
ExFg	EXCITER FIELD WINDING
Re	RECTIFIER
AVR	AUTOMATIC VOLTAGE REGULATOR
VR	VOLTAGE REGULATOR (RHEOSTAT)
CT 1,2	CURRENT TRANSFORMER
AS	CHANGE-OVER SWITCH, AMMETER
A	AC. AMMETER
V	AC. VOLTMETER
F	FREQUENCY METER
CB1	CIRCUIT BREAKER 3P 150A
CB2,3,4	CIRCUIT BREAKER 2P 50A
CB5,6	CIRCUIT BREAKER 1P 20A
CON1,2,3	RECEPTACLE, 250V @50A
CON4,5	RECEPTACLE, 125 @ 20A X 2, GFCI

WIRE SIZE

38 : 38.0 MM²

5.5 : 5.5 MM²

2 : 2.0 MM²

WITH NO DESIGNATION USE LEAD 1.25 MM²

CONTROLLER WIRING DIAGRAM (M1814101603C)

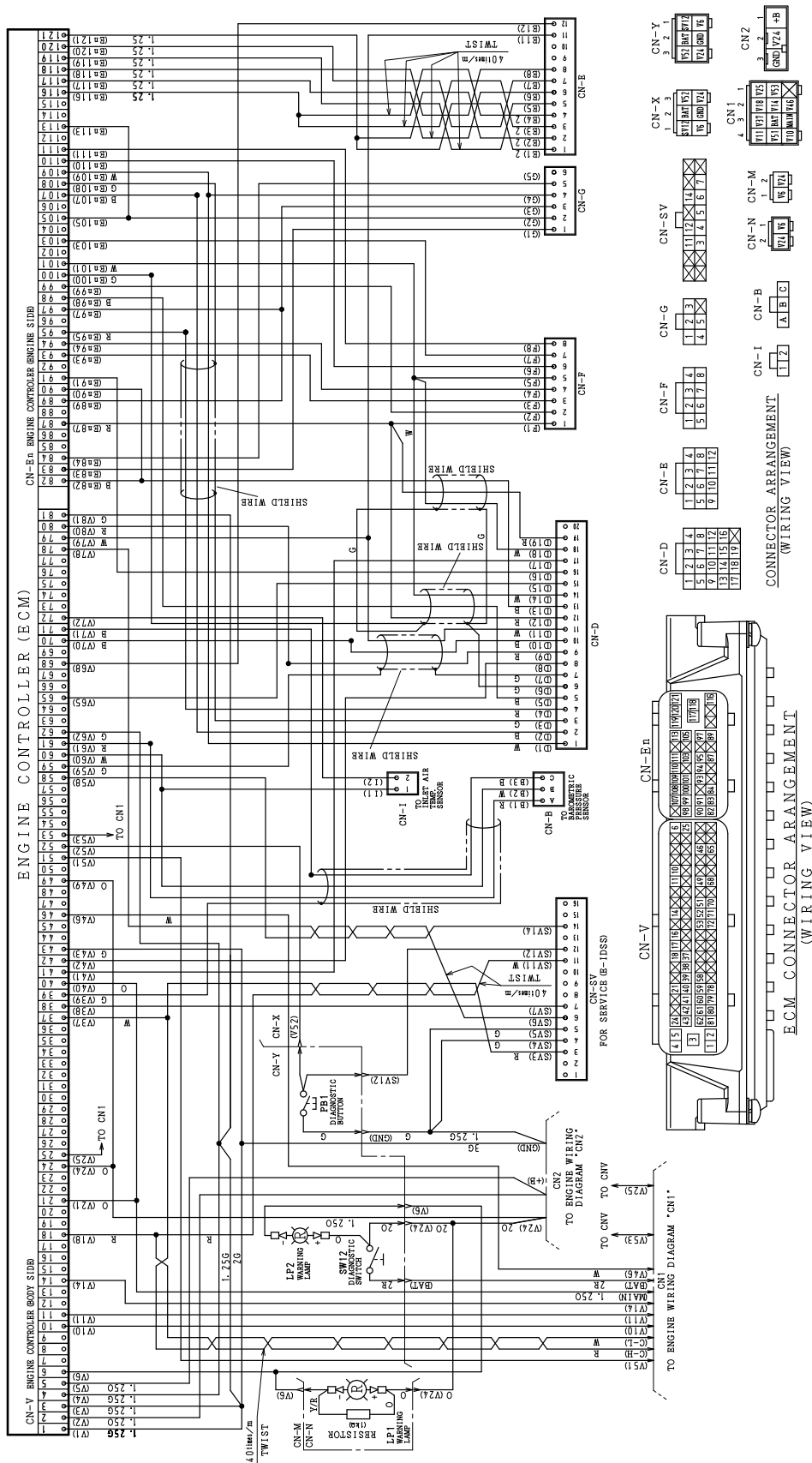

CONTROLLER WIRING DIAGRAM NO. M1814100603C

BATTERY CHARGER WIRING DIAGRAM (OPTION)

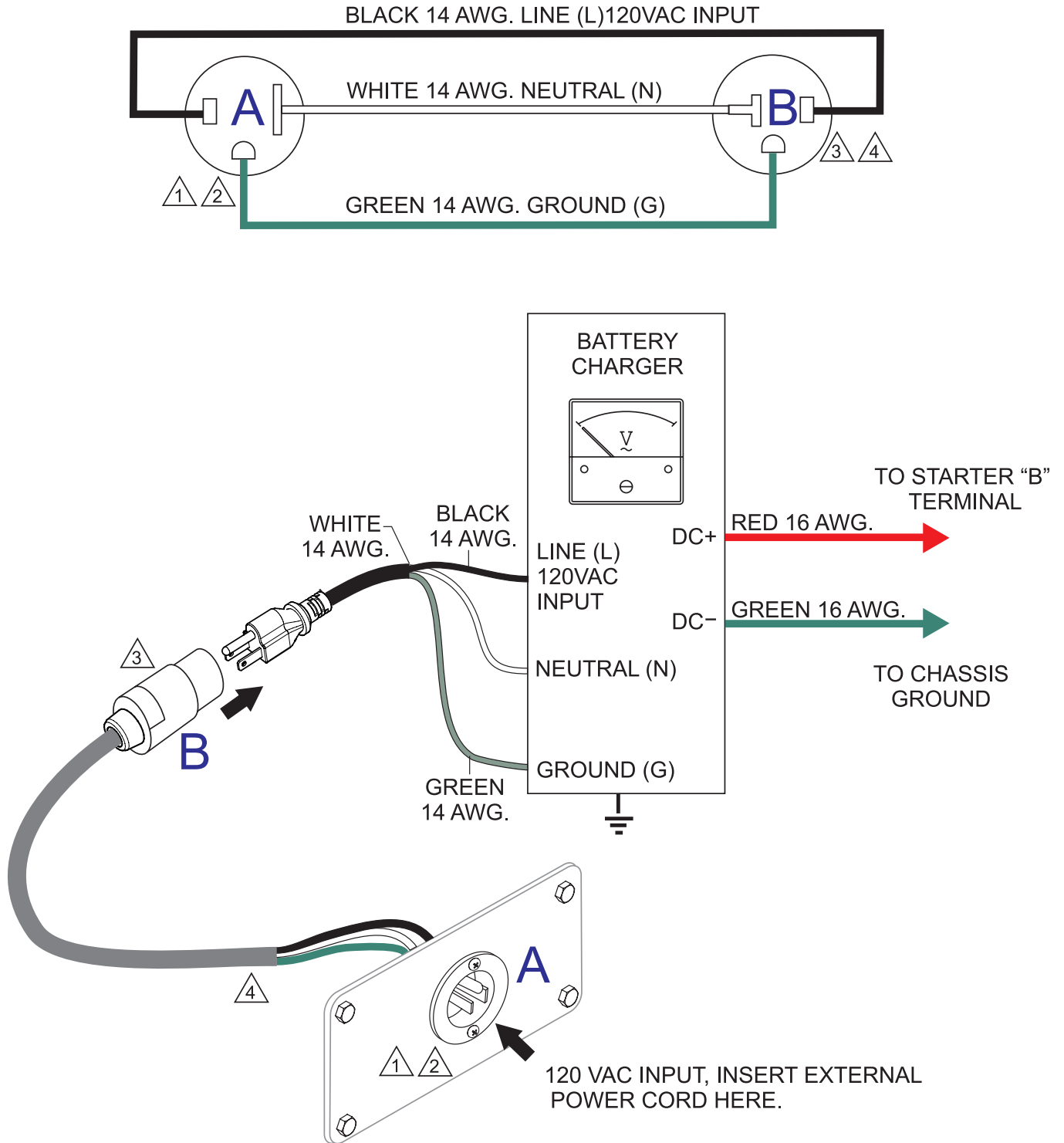

NOTES:

- ① NEMA 5-15, 15A, 120 VAC, P/N EE6176 (HBL5278C/HUBBLE RECEPTACLE).
- ② RECEPTACLE IS MOUNTED ON OUTPUT TERMINAL PANEL ASSY.
- ③ 20 AMP, 5-20R RECEPTACLE, P/N EE6131 (HBL5369C/HUBBLE RECEPTACLE).
- ④ CORD, CAROL 3/C 14 AWG., P/N EE56557.

ENGINE BLOCK HEATER WIRING DIAGRAM (OPTION)

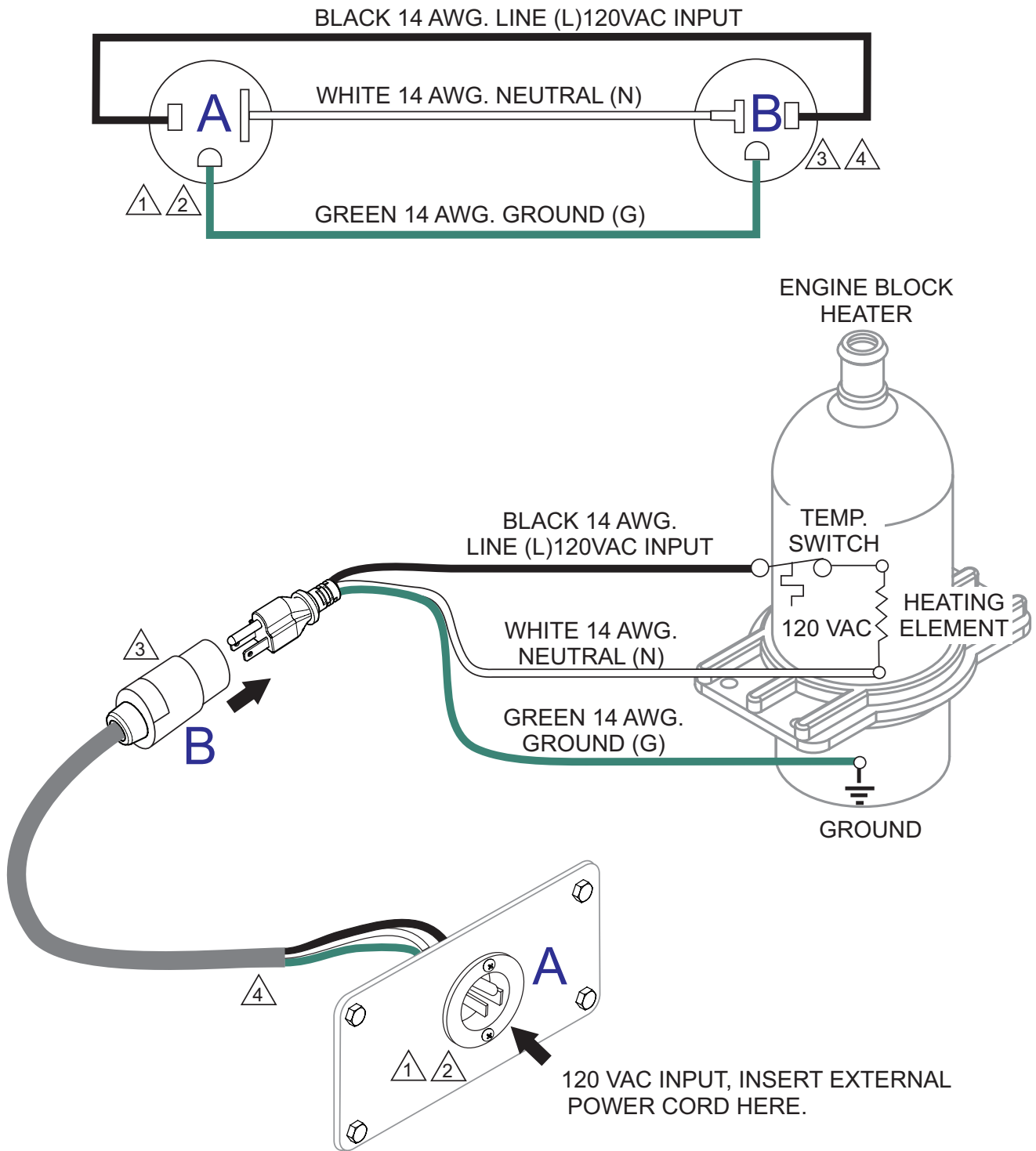

NOTES:

- ① NEMA 5-15, 15A, 120 VAC, P/N EE6176 (HBL5278C/HUBBLE RECEPTACLE).
- ② RECEPTACLE IS MOUNTED ON OUTPUT TERMINAL PANEL ASSY.
- ③ 20 AMP, 5-20R RECEPTACLE, P/N EE6131 (HBL5369C/HUBBLE RECEPTACLE).
- ④ CORD, CAROL 3/C 14 AWG., P/N EE56557.

OPERATION MANUAL

HERE'S HOW TO GET HELP

PLEASE HAVE THE MODEL AND SERIAL
NUMBER ON HAND WHEN CALLING

UNITED STATES

Multiquip Inc.

(310) 537- 3700
6141 Katella Avenue Suite 200
Cypress, CA 90630
E-MAIL: mq@multiquip.com
WEBSITE: www.multiquip.com

CANADA

Multiquip

(450) 625-2244
4110 Industriel Boul.
Laval, Quebec, Canada H7L 6V3
E-MAIL: infocanada@multiquip.com

UNITED KINGDOM

Multiquip (UK) Limited Head Office

0161 339 2223
Unit 2, Northpoint Industrial Estate, Globe Lane,
Dukinfield, Cheshire SK16 4UJ
E-MAIL: sales@multiquip.co.uk

© COPYRIGHT 2024, MULTIQUIP INC.

Multiquip Inc, the MQ logo and the MQ Power logo are registered trademarks of Multiquip Inc. and may not be used, reproduced, or altered without written permission. All other trademarks are the property of their respective owners and used with permission.

This manual MUST accompany the equipment at all times. This manual is considered a permanent part of the equipment and should remain with the unit if resold.

The information and specifications included in this publication were in effect at the time of approval for printing. Illustrations, descriptions, references and technical data contained in this manual are for guidance only and may not be considered as binding. Multiquip Inc. reserves the right to discontinue or change specifications, design or the information published in this publication at any time without notice and without incurring any obligations.

Manufactured for
MQ Power Inc.
by
DENYO MANUFACTURING CORP.

